



**OFFROAD & STREET**

**FORGED MOTORCYCLE PISTONS  
& MOTORCYCLE PARTS**

**2010/2011**



**W** ■ ■ HIGH PERFORMANCE PISTONS  
**Wossner**®  
RESEARCH & DEVELOPMENT  
Manufacturer of forged pistons



We are the innovative specialists for high performance pistons and conrods. Our products are to be found in engines operating at the highest levels of motor sport, in competition and, of course, in everyday use – in fact, anywhere where longevity and operational noise are important factors.

Wössner products are the source of the superior power behind the success of well known motor sport teams at national and international race meets.

# FORGED MOTORCYCLE PISTONS & MOTORCYCLE PARTS

## OFFROAD

<b>GasGas</b> .....	<b>5-8</b>
<b>Honda</b> .....	<b>9-21</b>
<b>Husaberg</b> .....	<b>22-24</b>
<b>Husqvarna</b> .....	<b>25-29</b>
<b>Kawasaki</b> .....	<b>30-38</b>
<b>KTM</b> .....	<b>39-46</b>
<b>Maico</b> .....	<b>47</b>
<b>Polaris</b> .....	<b>48-49</b>
<b>Suzuki</b> .....	<b>50-59</b>
<b>TM</b> .....	<b>60-61</b>
<b>VOR</b> .....	<b>62</b>
<b>Yamaha</b> .....	<b>63-78</b>

## STREET

<b>Aprilia</b> .....	<b>79-80</b>
<b>BMW</b> .....	<b>81</b>
<b>Cagiva</b> .....	<b>82</b>
<b>Ducati</b> .....	<b>83</b>
<b>Honda</b> .....	<b>84-85</b>
<b>Kawasaki</b> .....	<b>86-88</b>
<b>Suzuki</b> .....	<b>89</b>
<b>Yamaha</b> .....	<b>90</b>

### WARRANTY DISCLAIMER

Due to the nature of performance applications, the parts in this kit are sold without any express warranty or any implied warranty of merchantability or fitness for a particular purpose. Wössner GmbH shall not, under any circumstances, be liable for any special, incidental or consequential damages, including, but not limited to damage, or loss of profits or revenue, cost of purchased or replacement goods, or claims of customers of the purchaser, which may arise and/or result from sale, installation or use of these parts. Installation of these parts could adversely affect the vehicle manufacturer's warranty coverage. Pistons are useable for racing only.

<b>Conrods</b> .....	<b>91-92</b>
<b>Top End Gaskets</b> .....	<b>93</b>
<b>Needle Bearings</b> .....	<b>94</b>
<b>Pinlist</b> .....	<b>95-96</b>
<b>Ringlist</b> .....	<b>95-101</b>
<b>Terms and Conditions</b> .....	<b>102</b>
<b>Order Forms</b> .....	<b>103-104</b>

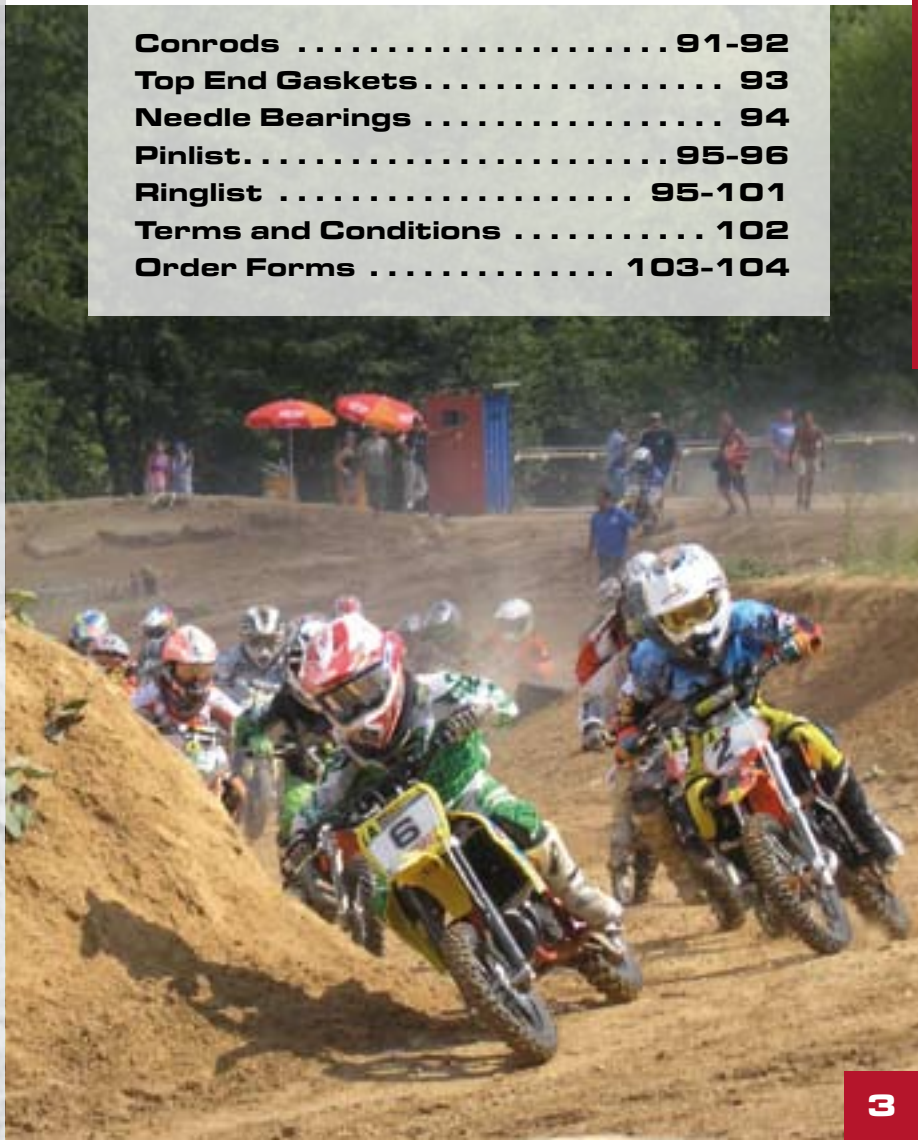

# PISTONS

## PERFORMANCE

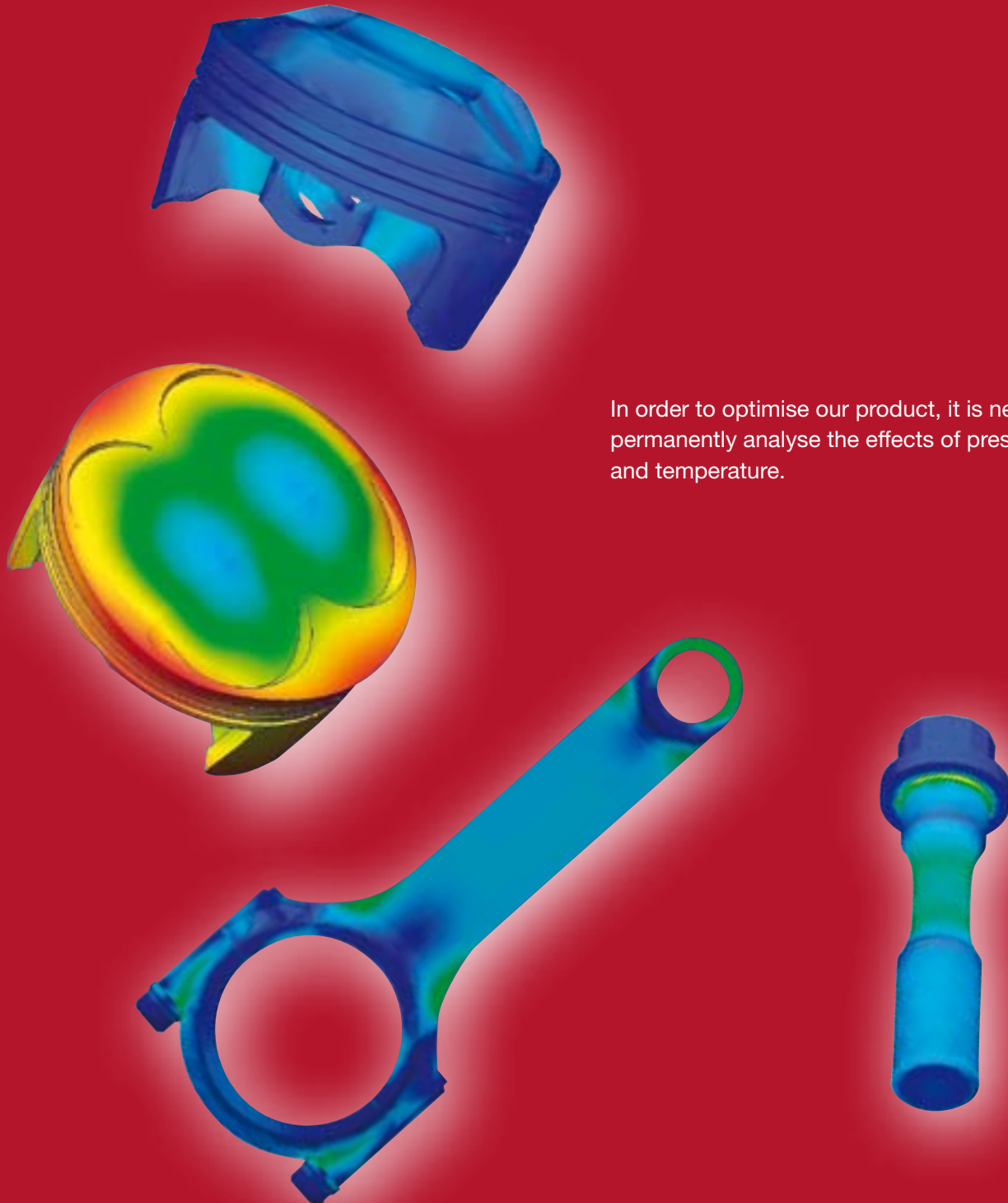

In order to optimise our product, it is necessary to permanently analyse the effects of pressure, motion and temperature.





## GASGAS 2-stroke



Model	Years	Displ. (cc)	Piston Size (mm)	Over-sizes (mm)	Piston Kit Part No.	Dome Volume (cm <sup>3</sup> )	Comp. Height (mm)	set includes				extra parts	
								Ring Set Part No.	Clip Part No.	Pin Part No.	Price-code	Top End Gasket Kit	Wössner Connecting Rods
MC 125	03-09	124	53.95	Std.	8080DA	-	28	RSB5400	CW15	WP032	2	D2042	-
			53.96	+0.01	8080DB			RSB5400	CW15	WP032	2		
			53.97	+0.02	8080DC			RSB5400	CW15	WP032	2		
EC 125	03-09	124	53.95	Std.	8079DA	-	28	RSB5400	CW15	WP032	2	D2042	-
			53.96	+0.01	8079DB			RSB5400	CW15	WP032	2		
			53.97	+0.02	8079DC			RSB5400	CW15	WP032	2		
TXT 125	03-09	124	53.95	Std.	8218DA	-	29.5	RDB5400	CW16	WP036	2	-	-
			53.96	+0.01	8218DB			RDB5400	CW16	WP036	2		
			53.97	+0.02	8218DC			RDB5400	CW16	WP036	2		
EC 200	03-09	199	62.45	Std.	8139DA	-	32	RDB6250	CW18	WP040	3	-	-
			62.46	+0.01	8139DB			RDB6250	CW18	WP040	3		
			62.47	+0.02	8139DC			RDB6250	CW18	WP040	3		
TXT 200	99-06	175	63.95	Std.	8132DA	-	30	RDB6400	CW16	WP027	3/1	-	-
			63.96	+0.01	8132DB			RDB6400	CW16	WP027	3/1		
			63.97	+0.02	8132DC			RDB6400	CW16	WP027	3/1		
MC & EC 250	03-09	249	66.33	Std.	8052DA	-	38	RDB6640	CW18	WP033	3	-	-
			66.34	+0.01	8052DB			RDB6640	CW18	WP033	3		
			66.35	+0.02	8052DC			RDB6640	CW18	WP033	3		
			66.36	+0.03	8052DD			RDB6640	CW18	WP033	3		
TXT 250	01-09	247	72.47	Std.	8163DA	-	-	RDB7250	CA18	WP033	3/1	-	-
			72.48	+0.01	8163DB			RDB7250	CA18	WP033	3/1		
			72.49	+0.02	8163DC			RDB7250	CA18	WP033	3/1		
TXT 280	all	272	75.96	Std.	8144DA	-	28.75	RDC7600	CA18	WP033	6	-	-
			75.97	+0.01	8144DB			RDC7600	CA18	WP033	6		
			75.98	+0.02	8144DC			RDC7600	CA18	WP033	6		
EC 300	03-09	297	71.93	Std.	8077DA	-	38	RDB7200	CW18	WP033	6	-	-
			71.94	+0.01	8077DB			RDB7200	CW18	WP033	6		
			71.95	+0.02	8077DC			RDB7200	CW18	WP033	6		
TXT 300	all	294	78.96	Std.	8145DA	-	28.75	RDC7900	CA18	WP033	6/1	-	-
			78.97	+0.01	8145DB			RDC7900	CA18	WP033	6/1		
			78.98	+0.02	8145DC			RDC7900	CA18	WP033	6/1		

## GASGAS-ATV 2-stroke



					set includes							extra parts		
														
Model	Years	Displ. (cc)	Piston Size (mm)	Over-sizes (mm)	Piston Kit Part No.	Dome Volume (cm <sup>3</sup> )	Comp. Height (mm)	Ring Set Part No.	Clip Part No.	Pin Part No.	Price-code	Top End Gasket Kit	Wössner Connecting Rods	
EC 300	03-09	297	71.93	Std.	8077DA	-	38	RDB7200	CW18	WP033	6	-	-	
			71.94	+0.01	8077DB			RDB7200	CW18	WP033	6			
			71.95	+0.02	8077DC			RDB7200	CW18	WP033	6			



## GASGAS 4-stroke







					set includes							extra parts	
Model	Years	Displ. (cc)	Piston Size (mm)	Over-sizes (mm)	Piston Kit Part No.	Dome Volume (cm <sup>3</sup> )	Comp. Height (mm)	Ring Set Part No.	Clip Part No.	Pin Part No.	Price-code	Top End Gasket Kit	Wössner Connecting Rods
HP, EC, FSE 450	03-04	443	94.95	Std.	8585DA	-	25.50	950XSY	CW20	WP038	7/1	-	-
			94.96	+0.01	8585DB			950XSY	CW20	WP038	7/1		
			94.97	+0.02	8585DC			950XSY	CW20	WP038	7/1		
HP, EC, FES 450	05	443	94.95	Std.	8615DA	-	25.50	950XSY	CW20	WP038	7/1	-	-
			94.96	+0.01	8615DB			950XSY	CW20	WP038	7/1		
			94.97	+0.02	8615DC			950XSY	CW20	WP038	7/1		
HP, EC, FES 450	06-09	449	96.95	Std.	8638DA	-	25.50	970ADS-2	CW20	WP038	7/1	-	-
			96.96	+0.01	8638DB			970ADS-2	CW20	WP038	7/1		
			96.97	+0.02	8638DC			970ADS-2	CW20	WP038	7/1		
SM450	07-09	449	96.95	Std.	8638DA	-	25.50	970ADS-2	CW20	WP038	7/1	-	-
			96.96	+0.01	8638DB			970ADS-2	CW20	WP038	7/1		
			96.97	+0.02	8638DC			970ADS-2	CW20	WP038	7/1		
SM515	09	515	99.95	Std.	8703DA	-	25.50	1000ADS-2	CW20	WP038	7	-	-
			99.96	+0.01	8703DB			1000ADS-2	CW20	WP038	7		
			99.97	+0.02	8703DC			1000ADS-2	CW20	WP038	7		



## GASGAS-ATV 4-stroke



					set includes							extra parts	
													
Model	Years	Displ. (cc)	Piston Size (mm)	Over-sizes (mm)	Piston Kit Part No.	Dome Volume (cm <sup>3</sup> )	Comp. Height (mm)	Ring Set Part No.	Clip Part No.	Pin Part No.	Price-code	Top End Gasket Kit	Wössner Connecting Rods
HP, EC, FSE 450	03-04	443	94.95	Std.	8585DA	-	25.50	950XSY	CW20	WP038	7/1	-	-
			94.96	+0.01	8585DB			950XSY	CW20	WP038	7/1		
			94.97	+0.02	8585DC			950XSY	CW20	WP038	7/1		
HP, EC, FES 450	05	443	94.95	Std.	8615DA	-	25.50	950XSY	CW20	WP038	7/1	-	-
			94.96	+0.01	8615DB			950XSY	CW20	WP038	7/1		
			94.97	+0.02	8615DC			950XSY	CW20	WP038	7/1		
HP, EC, FES 450	06-09	449	96.95	Std.	8638DA	-	25.50	970ADS-2	CW20	WP038	7/1	-	-
			96.96	+0.01	8638DB			970ADS-2	CW20	WP038	7/1		
			96.97	+0.02	8638DC			970ADS-2	CW20	WP038	7/1		









## HONDA 2-stroke



Model	Years	Displ. (cc)	Piston Size (mm)	Over-sizes (mm)	Piston Kit Part No.	Dome Volume (cm <sup>3</sup> )	Comp. Height (mm)	set includes				extra parts	
								Ring Set Part No.	Clip Part No.	Pin Part No.	Price-code	Top End Gasket Kit	Wössner Connecting Rods
CR80	86-91	80	46.95	Std.	8238DA	-	24	RSB4700	CW14	WP058	1/1	-	P2003
			47.45	+0.5	8238D050			RSB4750	CW14	WP058	1/1		
			47.95	+1.0	8238D100			RSB4800	CW14	WP058	1/1		
			48.95	+2.0	8238D200			RSB4750	CW14	WP058	1/1		
CR80 U.S Bore	92-02	80	46.95	Std.	8237DA	-	24	RSB4700	CW14	WP058	1/1	-	P2003
			47.45	+0.5	8237D050			RSB4750	CW14	WP058	1/1		
			47.95	+1.0	8237D100			RSB4800	CW14	WP058	1/1		
			48.95	+2.0	8237D200			RSB4750	CW14	WP058	1/1		
CR80 International Bore	86-02	80	45.95	Std.	8230DA	-	24	RSB4600	CW14	WP058	1/1	-	P2003
			45.96	+0.01	8230DB			RSB4600	CW14	WP058	1/1		
			45.97	+0.02	8230DC			RSB4600	CW14	WP058	1/1		
CR85	03-09	84.7	47.45	Std.	8105DA	-	24	RSB4750	CW14	WP058	1	D2001	P2003
			47.46	+0.01	8105DB			RSB4750	CW14	WP058	1		
			47.47	+0.02	8105DC			RSB4750	CW14	WP058	1		
CR125	79	123	55.94	Std.	8150DA	-	28.50	RDB5600	CW14	WP025	2/1	-	-
			56.19	+0.25	8150D025			RDB5625	CW14	WP025	2/1		
			56.44	+0.5	8150D050			RDB5650	CW14	WP025	2/1		
			56.69	+0.75	8150D075			RDB5675	CW14	WP025	2/1		
			56.94	+1.0	8150D100			RDB5700	CW14	WP025	2/1		
			57.44	+1.5	8150D150			RDB5750	CW14	WP025	2/1		
CR125	80-84	120	55.44	Std.	8149DA	-	28.50	RDB5550	CW14	WP025	2/1	-	P2040
			55.69	+0.25	8149D025			RDB5575	CW14	WP025	2/1		
			55.94	+0.5	8149D050			RDB5600	CW14	WP025	2/1		
			56.19	+0.75	8149D075			RDB5625	CW14	WP025	2/1		
			56.44	+1.0	8149D100			RDB5650	CW14	WP025	2/1		
			56.69	+1.25	8149D125			RDB5675	CW14	WP025	2/1		
			56.94	+1.5	8149D150			RDB5700	CW14	WP025	2/1		
			57.44	+2.0	8149D200			RDB5750	CW14	WP025	2/1		





## HONDA 2-stroke



					set includes							extra parts	
													
Model	Years	Displ. (cc)	Piston Size (mm)	Over-sizes (mm)	Piston Kit Part No.	Dome Volume (cm <sup>3</sup> )	Comp. Height (mm)	Ring Set Part No.	Clip Part No.	Pin Part No.	Price-code	Top End Gasket Kit	Wössner Connecting Rods
CR125	85-86	124	53.94	Std.	8127DA	-	28	RDB5400	CW14	WP025	2/1	-	P2041
			54.19	+0.25	8127D025			RDB5425	CW14	WP025	2/1		
			54.44	+0.5	8127D050			RDB5450	CW14	WP025	2/1		
			54.69	+0.75	8127D075			RDB5475	CW14	WP025	2/1		
			54.94	+1.0	8127D100			RDB5500	CW14	WP025	2/1		
			55.19	+1.25	8127D125			RDB5525	CW14	WP025	2/1		
			55.44	+1.5	8127D150			RDB5550	CW14	WP025	2/1		
			55.94	+2.0	8127D200			RDB5600	CW14	WP025	2/1		
CR125	87	124	53.94	Std.	8126DA	-	28	RSB5400	CW14	WP025	2/1	-	P2041
			54.19	+0.25	8126D025			RSB5425	CW14	WP025	2/1		
			54.44	+0.5	8126D050			RSB5450	CW14	WP025	2/1		
			54.69	+0.75	8126D075			RSB5475	CW14	WP025	2/1		
			54.94	+1.0	8126D100			RSB5500	CW14	WP025	2/1		
			55.19	+1.25	8126D125			RSB5525	CW14	WP025	2/1		
			55.44	+1.5	8126D150			RSB5550	CW14	WP025	2/1		
			55.94	+2.0	8126D200			RSB5600	CW14	WP025	2/1		
CR125	88-89	125	53.94	Std.	8125DA	-	28	RSB5400	CW15	WP032	2/1	-	P2009
			54.19	+0.25	8125D025			RSB5425	CW15	WP032	2/1		
			54.44	+0.5	8125D050			RSB5450	CW15	WP032	2/1		
			54.69	+0.75	8125D075			RSB5475	CW15	WP032	2/1		
			54.94	+1.0	8125D100			RSB5500	CW15	WP032	2/1		
			55.19	+1.25	8125D125			RSB5525	CW15	WP032	2/1		
			55.44	+1.5	8125D150			RSB5550	CW15	WP032	2/1		
			55.94	+2.0	8125D200			RSB5600	CW15	WP032	2/1		
CR125	90-91	125	53.94	Std.	8107DA	-	28	RSB5400	CW15	WP032	2	D2002	P2009
			53.95	+0.01	8107DB			RSB5400	CW15	WP032	2		
			53.96	+0.02	8107DC			RSB5400	CW15	WP032	2		
			54.44	+0.5	8107D050			RSB5450	CW15	WP032	2		
			54.94	+1.0	8107D100			RSB5500	CW15	WP032	2		





## HONDA 2-stroke



					set includes							extra parts	
													
Model	Years	Displ. (cc)	Piston Size (mm)	Over-sizes (mm)	Piston Kit Part No.	Dome Volume (cm <sup>3</sup> )	Comp. Height (mm)	Ring Set Part No.	Clip Part No.	Pin Part No.	Price-code	Top End Gasket Kit	Wössner Connecting Rods
CR125 No intake window Pinned on centerline Longer skirt than stock	92-99	125	53.95	Std.	8020DA	-	28	RSB5400	CW15	WP032	2	D2002 / D2003	P2009
			53.96	+0.01	8020DB			RSB5400	CW15	WP032	2		
			53.97	+0.02	8020DC			RSB5400	CW15	WP032	2		
			53.98	+0.03	8020DD			RSB5400	CW15	WP032	2		
			54.45	+0.5	8020D050			RSB5450	CW15	WP032	2		
54.95	+1.0	8020D100	RSB5500	CW15	WP032	2							
CR125	00-03	125	53.95	Std.	8067DA	-	28	RSB5400	CW15	WP032	2	D2004 / D2005	P2009
			53.96	+0.01	8067DB			RSB5400	CW15	WP032	2		
			53.97	+0.02	8067DC			RSB5400	CW15	WP032	2		
			54.45	+0.5	8067D050			RSB5450	CW15	WP032	2		
			54.95	+1.0	8067D100			RSB5500	CW15	WP032	2		
CR125	04	125	53.95	Std.	8100DA	-	28	RSB5400	CW15	WP032	2/1	D2006	P2009
			53.96	+0.01	8100DB			RSB5400	CW15	WP032	2/1		
			53.97	+0.02	8100DC			RSB5400	CW15	WP032	2/1		
			55.95	+2.0	8100D200			RSB5600	CW15	WP032	2/1		
CR125	05-09	125	53.95	Std.	8170DA	-	28	RSB5400	CW15	WP032	2	D2007	P2009
			53.96	+0.01	8170DB			RSB5400	CW15	WP032	2		
			53.97	+0.02	8170DC			RSB5400	CW15	WP032	2		
			55.95	+2.0	8170D200			RSB5600	CW15	WP032	2		
			57.95	+4.0	8170D400			RSB5800	CW15	WP032	2		
MBX & MTX125	83-87	124	55.94	Std.	8024DA	-	30.40	RDB5600	CW16	WP036	2	-	-
			56.44	+0.5	8024D050			RDB5650	CW16	WP036	2		
			56.94	+1.0	8024D100			RDB5700	CW16	WP036	2		
			57.44	+1.5	8024D150			RDB5750	CW16	WP036	2		
MTX125 Rally	88-90	124	55.94	Std.	8190DA	-	30.60	RDB5600	CW16	WP036	2/1	-	-
			55.95	+0.01	8190DB			RDB5600	CW16	WP036	2/1		
			55.96	+0.02	8190DC			RDB5600	CW16	WP036	2/1		
			55.97	+0.03	8190DD			RDB5600	CW16	WP036	2/1		
NSR & CRM125 R	91-03	124	53.94	Std.	8019DA	-	30	RDB5400	CW16	WP036	2	-	-
			53.95	+0.01	8019DB			RDB5400	CW16	WP036	2		
			53.96	+0.02	8019DC			RDB5400	CW16	WP036	2		
			54.44	+0.5	8019D050			RDB5450	CW16	WP036	2		
			54.94	+1.0	8019D100			RDB5500	CW16	WP036	2		

## HONDA 2-stroke



					set includes							extra parts		
														
Model	Years	Displ. (cc)	Piston Size (mm)	Over-sizes (mm)	Piston Kit Part No.	Dome Volume (cm <sup>3</sup> )	Comp. Height (mm)	Ring Set Part No.	Clip Part No.	Pin Part No.	Price-code	Top End Gasket Kit	Wössner Connecting Rods	
CR, MR, MT250	73-74	248	69.94	Std.	8152DA	-	32	RDB7000	CW18	WP033	3/1	-	-	
			70.44	+0.5	8152D050			RDB7050	CW18	WP033	3/1			
			70.94	+1.0	8152D100			RDB7100	CW18	WP033	3/1			
			71.44	+1.5	8152D150			RDB7150	CW18	WP033	3/1			
			71.94	+2.0	8152D200			RDB7200	CW18	WP033	3/1			
CR, MR, MT250	75-77	248	69.94	Std.	8153DA	-	32	RDB7000	CW18	WP033	3/1	-	-	
			70.44	+0.5	8153D050			RDB7050	CW18	WP033	3/1			
			70.94	+1.0	8153D100			RDB7100	CW18	WP033	3/1			
			71.44	+1.5	8153D150			RDB7150	CW18	WP033	3/1			
			71.94	+2.0	8153D200			RDB7200	CW18	WP033	3/1			
CR250R	78-80	248	69.94	Std.	8154DA	-	32.50	RDB7000	CW18	WP033	3/1	-	-	
			70.19	+0.25	8154D025			RDB7025	CW18	WP033	3/1			
			70.44	+0.5	8154D050			RDB7050	CW18	WP033	3/1			
			70.69	+0.75	8154D075			RDB7075	CW18	WP033	3/1			
			70.94	+1.0	8154D100			RDB7100	CW18	WP033	3/1			
			71.19	+1.25	8154D125			RDB7125	CW18	WP033	3/1			
			71.44	+1.5	8154D150			RDB7150	CW18	WP033	3/1			
71.94	+2.0	8154D200	RDB7200	CW18	WP033	3/1								
CR250R	81-83	246	65.94	Std.	8155DA	-	41.20	RDB6600	CW18	WP033	3/1	-	-	
			66.44	+0.5	8155D050			RDB6650	CW18	WP033	3/1			
			66.69	+0.75	8155D075			RDB6675	CW18	WP033	3/1			
			66.94	+1.0	8155D100			RDB6700	CW18	WP033	3/1			
			67.44	+1.5	8155D150			RDB6750	CW18	WP033	3/1			
			67.94	+2.0	8155D200			RDB6800	CW18	WP033	3/1			

## HONDA 2-stroke



					set includes							extra parts	
Model	Years	Displ. (cc)	Piston Size (mm)	Over-sizes (mm)	Piston Kit Part No.	Dome Volume (cm <sup>3</sup> )	Comp. Height (mm)	Ring Set Part No.	Clip Part No.	Pin Part No.	Price-code	Top End Gasket Kit	Wössner Connecting Rods
CR250R, ATAC	84-85	246	65.94	Std.	8156DA	-	38	RDB6600	CW18	WP033	3/1	-	P2021
			66.19	+0.25	8156D025			RDB6625	CW18	WP033	3/1		
			66.44	+0.5	8156D050			RDB6650	CW18	WP033	3/1		
			66.69	+0.75	8156D075			RDB6675	CW18	WP033	3/1		
			66.94	+1.0	8156D100			RDB6700	CW18	WP033	3/1		
			67.19	+1.25	8156D125			RDB6725	CW18	WP033	3/1		
			67.44	+1.5	8156D150			RDB6750	CW18	WP033	3/1		
			67.94	+2.0	8156D200			RDB6800	CW18	WP033	3/1		
			68.44	+2.5	8156D250			RDB6850	CW18	WP033	3/1		
			68.94	+3.0	8156D300			RDB6900	CW18	WP033	3/1		
			69.44	+3.5	8156D350			RDB6950	CW18	WP033	3/1		
CR250R	86-96	249	66.34	Std.	8021DA	-	38	RDB6640	CW18	WP033	3	D2008	P2021
			66.35	+0.01	8021DB			RDB6640	CW18	WP033	3		
			66.36	+0.02	8021DC			RDB6640	CW18	WP033	3		
			66.94	+0.6	8021D060			RDB6700	CW18	WP033	3		
			67.44	+1.1	8021D110			RDB6750	CW18	WP033	3		
			67.94	+1.6	8021D160			RDB6800	CW18	WP033	3		
			68.44	+2.1	8021D210			RDB6850	CW18	WP033	3		
CR250R	97-01	249	66.34	Std.	8001DA	-	38	RDB6640	CW18	WP033	3	D2008	P2021
			66.35	+0.01	8001DB			RDB6640	CW18	WP033	3		
			66.36	+0.02	8001DC			RDB6640	CW18	WP033	3		
			66.94	+0.6	8001D060			RDB6700	CW18	WP033	3		
			67.44	+1.1	8001D110			RDB6750	CW18	WP033	3		
			67.94	+1.6	8001D160			RDB6800	CW18	WP033	3		
			68.44	+2.1	8001D210			RDB6850	CW18	WP033	3		
CR250R Single Ring	97-01	249	66.34	Std.	8161DA	-	38	RSB6640	CW18	WP033	3/1	D2008	P2021
			66.35	+0.01	8161DB			RSB6640	CW18	WP033	3/1		
			66.36	+0.02	8161DC			RSB6640	CW18	WP033	3/1		
			66.94	+0.6	8161D060			RSB6700	CW18	WP033	3/1		
			67.44	+1.1	8161D110			RSB6750	CW18	WP033	3/1		
			67.94	+1.6	8161D160			RSB6800	CW18	WP033	3/1		
			68.44	+2.1	8161D210			RSB6850	CW18	WP033	3/1		





## HONDA 2-stroke



Model	Years	Displ. (cc)	Piston Size (mm)	Over-sizes (mm)	Piston Kit Part No.	Dome Volume (cm <sup>3</sup> )	Comp. Height (mm)	set includes				extra parts	
								Ring Set Part No.	Clip Part No.	Pin Part No.	Price-code	Top End Gasket Kit	Wössner Connecting Rods
CR250R	02-04	249	66.34	Std.	8066DA	-	38	RDB6640	CW18	WP033	3	D2009	P2020
			66.35	+0.01	8066DB			RDB6640	CW18	WP033	3		
			66.36	+0.02	8066DC			RDB6640	CW18	WP033	3		
			66.94	+0.6	8066D060			RDB6700	CW18	WP033	3		
			67.44	+1.1	8066D110			RDB6750	CW18	WP033	3		
			67.94	+1.6	8066D160			RDB6800	CW18	WP033	3		
			68.44	+2.1	8066D210			RDB6850	CW18	WP033	3		
CR250R Single Ring	02-04	249	66.34	Std.	8164DA	-	38	RSB6640	CW18	WP033	3/1	D2009	P2020
			66.35	+0.01	8164DB			RSB6640	CW18	WP033	3/1		
			66.36	+0.02	8164DC			RSB6640	CW18	WP033	3/1		
			66.94	+0.6	8164D060			RDB6700	CW18	WP033	3/1		
			67.44	+1.1	8164D110			RDB6750	CW18	WP033	3/1		
			67.94	+1.6	8164D160			RDB6800	CW18	WP033	3/1		
			68.44	+2.1	8164D210			RSB6850	CW18	WP033	3/1		
CR250R	05-09	249	66.34	Std.	8171DA	-	38	RDB6640	CW18	WP033	3	D2009	P2020
			66.35	+0.01	8171DB			RDB6640	CW18	WP033	3		
			66.36	+0.02	8171DC			RDB6640	CW18	WP033	3		
			68.44	+2.1	8171D210			RDB6850	CW18	WP033	3		
CR250R Single Ring	05-09	249	66.34	Std.	8172DA	-	38	RSB6640	CW18	WP033	3/1	D2009	P2020
			66.35	+0.01	8172DB			RSB6640	CW18	WP033	3/1		
			66.36	+0.02	8172DC			RSB6640	CW18	WP033	3/1		
			68.44	+2.1	8172D210			RSB6850	CW18	WP033	3/1		
CRM250	all	249	65.93	Std.	8071DA	-	33	RDB6600	CW19	WP044	3	-	-
			65.94	+0.01	8071DB			RDB6600	CW19	WP044	3		
			65.95	+0.02	8071DC			RDB6600	CW19	WP044	3		
			66.33	+0.40	8071D040			RDB6640	CW19	WP044	3		
			66.43	+0.50	8071D050			RDB6650	CW19	WP044	3		
			66.93	+1.0	8071D100			RDB6700	CW19	WP044	3		
			67.43	+1.5	8071D150			RDB6750	CW19	WP044	3		
			67.93	+2.0	8071D200			RDB6800	CW19	WP044	3		
CR500	84-89	500	88.93	Std.	8229DA	-	40	RSC8900	CW20	WP086	6/1	-	P2044
			89.43	+0.5	8229D050			RSC8950	CW20	WP086	6/1		
			89.93	+1.0	8229D100			RSC9000	CW20	WP086	6/1		
			90.43	+1.5	8229D150			RSC9050	CW20	WP086	6/1		
			90.93	+2.0	8229D200			RSC9100	CW20	WP086	6/1		





## HONDA-ATV 2-stroke



					set includes							extra parts		
														
Model	Years	Displ. (cc)	Piston Size (mm)	Over-sizes (mm)	Piston Kit Part No.	Dome Volume (cm <sup>3</sup> )	Comp. Height (mm)	Ring Set Part No.	Clip Part No.	Pin Part No.	Price-code	Top End Gasket Kit	Wössner Connecting Rods	
ATC250R	81-84	248	69.94	Std.	8154DA	-	32.50	RDB7000	CW18	WP033	3/1	-	P2043	
			70.19	+0.25	8154D025			RDB7025	CW18	WP033	3/1			
			70.44	+0.5	8154D050			RDB7050	CW18	WP033	3/1			
			70.69	+0.75	8154D075			RDB7075	CW18	WP033	3/1			
			70.94	+1.0	8154D100			RDB7100	CW18	WP033	3/1			
			71.19	+1.25	8154D125			RDB7125	CW18	WP033	3/1			
			71.44	+1.5	8154D150			RDB7150	CW18	WP033	3/1			
			71.94	+2.0	8154D200			RDB7200	CW18	WP033	3/1			
ATC250R & TRX250R	85-86	246	65.94	Std.	8156DA	-	38	RDB6600	CW18	WP033	3/1	-	P2021	
			66.19	+0.25	8156D025			RDB6625	CW18	WP033	3/1			
			66.44	+0.5	8156D050			RDB6650	CW18	WP033	3/1			
			66.69	+0.75	8156D075			RDB6675	CW18	WP033	3/1			
			66.94	+1.0	8156D100			RDB6700	CW18	WP033	3/1			
			67.19	+1.25	8156D125			RDB6725	CW18	WP033	3/1			
			67.44	+1.5	8156D150			RDB6750	CW18	WP033	3/1			
			67.94	+2.0	8156D200			RDB6800	CW18	WP033	3/1			
			68.44	+2.5	8156D250			RDB6850	CW18	WP033	3/1			
			68.94	+3.0	8156D300			RDB6900	CW18	WP033	3/1			
69.44	+3.5	8156D350	RDB6950	CW18	WP033	3/1								
ATC250R & TRX250R	87-90	246	65.94	Std.	8189DA	-	33	RDB6600	CW18	WP033	3/1	-	P2042	
			66.44	+0.5	8189D050			RDB6650	CW18	WP033	3/1			
			66.94	+1.0	8189D100			RDB6700	CW18	WP033	3/1			
			67.44	+1.5	8189D150			RDB6750	CW18	WP033	3/1			
			67.94	+2.0	8189D200			RDB6800	CW18	WP033	3/1			

## HONDA 4-stroke



					set includes							extra parts	
													
Model	Years	Displ. (cc)	Piston Size (mm)	Over-sizes (mm)	Piston Kit Part No.	Dome Volume (cm <sup>3</sup> )	Comp. Height (mm)	Ring Set Part No.	Clip Part No.	Pin Part No.	Price-code	Top End Gasket Kit	Wössner Connecting Rods
CRF150R Hi-Comp. 12.5:1 (D400 = 13.0:1)	07-09	149 (D400 = 170)	65.95	Std.	8662DA	-1,8	20.60	660XKS-3	CW14	WP058	4	D4001	P4024
			65.96	+0.01	8662DB			660XKS-3	CW14	WP058	4		
			65.97	+0.02	8662DC			660XKS-3	CW14	WP058	4		
			67.95	+2.0	8662D200			680XKS	CW14	WP058	4		
			69.95	+4.0	8662D400			700XDS	CW14	WP058	4/1		
CRF 230F	03-09	230	65.46	Std.	8774DA	-	21.20	655XGS	CW15	WP011	5	D4002	-
			65.47	+0.01	8774DB			655XGS	CW15	WP011	5		
			65.48	+0.02	8774DC			655XGS	CW15	WP011	5		
			65.96	+0.5	8774D050			660XKS	CW15	WP011	5		
			66.46	+1.0	8774D100			665XKS	CW15	WP011	5		
			66.96	+1.5	8774D150			670XKS	CW15	WP011	5		
			67.46	+2.0	8774D200			675XKS	CW15	WP011	5		
XL250 / XR250	79-82 thru 83	-	73.94	Std.	8791DA	-	27.40	740XDS	CW19	WP028	5	-	-
			74.44	+0.5	8791D050			745XDS	CW19	WP028	5		
			74.94	+1.0	8791D100			750XDS	CW19	WP028	5		
			75.44	+1.5	8791D150			755XDS	CW19	WP028	5		
			75.94	+2.0	8791D200			760XDS	CW19	WP028	5		
XR / XL250	84-87	-	74.94	Std.	8792DA	-	25.40	750XDS	CW17	WP090	5	-	-
			75.44	+0.5	8792D050			755XDS	CW17	WP090	5		
			75.94	+1.0	8792D100			760XDS	CW17	WP090	5		
XR / XL250	86-04 91-96	-	72.94	Std.	8793DA	-	25	730XDS	CW17	WP090	5	-	-
			73.44	+0.5	8793D050			735XDS	CW17	WP090	5		
			73.94	+1.0	8793D100			740XDS	CW17	WP090	5		
			75.44	+2.5	8793D250			755XDS	CW17	WP090	5		
			76.94	+4.0	8793D400			770XDS	CW17	WP090	5		
			77.94	+5.0	8793D500			780XDS	CW17	WP090	5		
CRF250 & CRF250X 12.9:1	04-05	249	77.95	Std.	8587DA	-1	18.90	780XAS-2	CW16	WP059	5	D4004	P4001
			77.96	+0.01	8587DB			780XAS-2	CW16	WP059	5		
			77.97	+0.02	8587DC			780XAS-2	CW16	WP059	5		
			81.95	+4.0	8587D400			820XSY	CW16	WP059	5/1		



## HONDA 4-stroke



Model	Years	Displ. (cc)	Piston Size (mm)	Over-sizes (mm)	Piston Kit Part No.	Dome Volume (cm <sup>3</sup> )	Comp. Height (mm)	set includes				extra parts	
								Ring Set Part No.	Clip Part No.	Pin Part No.	Price-code	Top End Gasket Kit	Wössner Connecting Rods
CRF250 & CRF250X Hi-Compr. 13.9:1	04-09	249	77.96	Std.	8590DA	+0	19	780XAS-2	CW16	WP059	5	D4004	P4001
			77.97	+0.01	8590DB			780XAS-2	CW16	WP059	5		
			77.98	+0.02	8590DC			780XAS-2	CW16	WP059	5		
CRF250 & CRF250X 13.5:1	06-09	249	77.96	Std.	8656DA	-0,9	19	780XAS-2	CW16	WP059	5	D4004	P4001
			77.97	+0.01	8656DB			780XAS-2	CW16	WP059	5		
			77.98	+0.02	8656DC			780XAS-2	CW16	WP059	5		
			79.96	+2.0	8656D200			800XDS-3	CW16	WP059	5/1		
CRF450R	02-03	449	95.96	Std.	8546DA	-2,2	24	960ADS-2	CW19	WP037	7	D4006	P4026
			95.97	+0.01	8546DB			960ADS-2	CW19	WP037	7		
			95.98	+0.02	8546DC			960ADS-2	CW19	WP037	7		
CRF450R Big Bore Hi-Compr.	02-08	496	95.96	Std.	8546D400A	-2,2	24	1000ADS-2	CW19	WP037	7/1	-	P4026
			99.97	+0.01	8546D400B			1000ADS-2	CW19	WP037	7/1		
CRF450R	02-08	449	99.96	+4.00	8584D400A	-	24	1000XSY	CW19	WP037	7/1	D4006 / D4007	P4026
			99.97	+4.01	8584D400B			1000XSY	CW19	WP037	7/1		
CRF450R	04	449	95.96	Std.	8607DA	-1,7	24	960ADS-2	CW19	WP037	7	D4006	P4026
			95.97	+0.01	8607DB			960ADS-2	CW19	WP037	7		
			95.98	+0.02	8607DC			960ADS-2	CW19	WP037	7		
CRF450R 12:1	05-08	449	95.96	Std.	8608DA	-1,4	24	960ADS-2	CW19	WP037	7	D4006 / D4007	P4026
			95.97	+0.01	8608DB			960ADS-2	CW19	WP037	7		
			95.98	+0.02	8608DC			960ADS-2	CW19	WP037	7		
CRF450R Hi-Compr. 13.5:1 Pro Series	02-08	449	95.96	Std.	8668DA	+3,5	24	960ADS-2	CW19	WP037	7/1	D4006 / D4007	P4026
			95.97	+0.01	8668DB			960ADS-2	CW19	WP037	7/1		
			95.98	+0.02	8668DC			960ADS-2	CW19	WP037	7/1		
CRF450R 12:1	09-10	449	95.96	Std.	8739DA	-4,6	20.70	960ADS-2	CW19	WP037	7	D4008	P4027
			95.97	+0.01	8739DB			960ADS-2	CW19	WP037	7		
			95.98	+0.02	8739DC			960ADS-2	CW19	WP037	7		
CRF450R Hi-Compr. 13.5:1 Pro Series	09-10	449	95.96	Std.	8768DA	-	-	960ADS-2	CW19	WP037	7	D4008	P4027
			95.97	+0.01	8768DB			960ADS-2	CW19	WP037	7		
			95.98	+0.02	8768DC			960ADS-2	CW19	WP037	7		
XR350R will not fit for XL models	83-84	339	83.94	Std.	8641DA	-	-	840XSY	CW21	WP034	7/1	-	-
			84.44	+0.5	8641D050			845XSY	CW21	WP034	7/1		
			84.94	+1.0	8641D100			850XSY	CW21	WP034	7/1		

## HONDA 4-stroke



Model	Years	Displ. (cc)	Piston Size (mm)	Over-sizes (mm)	Piston Kit Part No.	Dome Volume (cm <sup>3</sup> )	Comp. Height (mm)	set includes				extra parts	
								Ring Set Part No.	Clip Part No.	Pin Part No.	Price-code	Top End Gasket Kit	Wössner Connecting Rods
XLR & XLS400	81-82	-	88.94	Std.	8642DA	-	-	890XSY-3	CW21	WP034	7	-	-
			89.44	+0.5	8642D050			895XSY	CW21	WP034	7		
			89.94	+1.0	8642D100			900XSY	CW21	WP034	7		
			90.44	+1.5	8642D150			905XSY	CW21	WP034	7		
			90.94	+2.0	8642D200			910XSY-3	CW21	WP034	7		
XR400	96-04	397	84.94	Std.	8604DA	-	26.20	850XSY	CW20	WP052	7/1	-	P4033
			84.95	+0.01	8604DB			850XSY	CW20	WP052	7/1		
			84.96	+0.02	8604DC			850XSY	CW20	WP052	7/1		
			85.44	+0.5	8604D050			855XSY	CW20	WP052	7/1		
			85.94	+1.0	8604D100			860XSY-3	CW20	WP052	7/1		
			86.44	+1.5	8604D150			865XSY-3	CW20	WP052	7/1		
			86.94	+2.0	8604D200			870XSY-3	CW20	WP052	7/1		
			87.44	+2.5	8604D250			875XSY-3	CW20	WP052	7/1		
87.94	+3.0	8604D300	880XSY	CW20	WP052	7/1							
XLR & XLS500 & XR500R	79-84	497	88.94	Std.	8642DA	-	-	890XSY-3	CW21	WP034	7	-	-
	79-82		89.44	+0.5	8642D050			895XSY	CW21	WP034	7		
			89.94	+1.0	8642D100			900XSY	CW21	WP034	7		
			90.44	+1.5	8642D150			905XSY	CW21	WP034	7		
			90.94	+2.0	8642D200			910XSY-3	CW21	WP034	7		
XR600R	85-99	591-654	96.94	Std.	8574DA	-	29.70	970XSY	CW24	WP022	7/1	-	P4028
			96.95	+0.01	8574DB			970XSY	CW24	WP022	7/1		
			96.96	+0.02	8574DC			970XSY	CW24	WP022	7/1		
			97.44	+0.5	8574D050			975XSY	CW24	WP022	7/1		
			97.94	+1.0	8574D100			980XSY	CW24	WP022	7/1		
			98.94	+2.0	8574D200			990XSY	CW24	WP022	7/1		
			99.94	+3.0	8574D300			1000XSY	CW24	WP022	7/1		
			100.94	+4.0	8574D400			1010XSY-3	CW24	WP022	7/1		
			101.94	+5.0	8574D500			1020XSU	CW24	WP022	7/1		

## HONDA 4-stroke







Model	Years	Displ. (cc)	Piston Size (mm)	Over-sizes (mm)	Piston Kit Part No.	Dome Volume (cm <sup>3</sup> )	Comp. Height (mm)	set includes				extra parts	
								Ring Set Part No.	Clip Part No.	Pin Part No.	Price-code	Top End Gasket Kit	Wössner Connecting Rods
NX650 Dominator / XR650C / XR650L	88-01 93-99 96-07	650	99.93	Std.	8564DA	+0	29	1000XSY	CW24	WP057	7	-	-
			99.94	+0.01	8564DB			1000XSY	CW24	WP057	7		
			99.95	+0.02	8564DC			1000XSY	CW24	WP057	7		
			100.93	+1.0	8564D100			1010XSY-3	CW24	WP057	7		
			101.93	+2.0	8564D200			1020XSU	CW24	WP057	7		
XR650R will not fit for XR650L 10:1	00-07	644	99.94	Std.	8575DA	-	29	1000XSY	CW23	WP024	7/1	-	-
			99.95	+0.01	8575DB			1000XSY	CW23	WP024	7/1		
			99.96	+0.02	8575DC			1000XSY	CW23	WP024	7/1		
			100.94	+1.0	8575D100			1010XSY-3	CW23	WP024	7/1		
			101.94	+2.0	8575D200			1020XSU	CW23	WP024	7/1		
XR650R 11:1 will not fit for XR650L	00-07	644	99.94	Std.	8718DA	-	-	1000XSY	CW23	WP024	7/1	-	-
			99.95	+0.01	8718DB			1000XSY	CW23	WP024	7/1		
			99.96	+0.02	8718DC			1000XSY	CW23	WP024	7/1		
			100.94	+1.0	8718D100			1010XSY-3	CW23	WP024	7/1		
			101.94	+2.0	8718D200			1020XSU	CW23	WP024	7/1		



## HONDA-ATV 4-stroke



					set includes							extra parts		
														
Model	Years	Displ. (cc)	Piston Size (mm)	Over-sizes (mm)	Piston Kit Part No.	Dome Volume (cm <sup>3</sup> )	Comp. Height (mm)	Ring Set Part No.	Clip Part No.	Pin Part No.	Price-code	Top End Gasket Kit	Wössner Connecting Rods	
TRX300EX 4 Valve	92-08	282	73.94	Std.	8675DA	-	23.30	740XDS	CW17	WP090	5/1	-	-	
			74.44	+0.50	8675D050			745XDS	CW17	WP090	5/1			
			74.94	+1.0	8675D100			750XDS	CW17	WP090	5/1			
			75.44	+1.5	8675D150			755XDS	CW17	WP090	5/1			
			75.94	+2.0	8675D200			760XDS	CW17	WP090	5/1			
ATC350X & TRX350	85-89	350	80.94	Std.	8598DA	-	26.70	810XSY	CW21	WP034	5/1	-	-	
			81.44	+0.5	8598D050			815XSY	CW21	WP034	5/1			
			81.94	+1.0	8598D100			820XSY	CW21	WP034	5/1			
TRX400EX 11:1	99-08	397	84.94	Std.	8604DA	-	26.20	850XSY	CW20	WP052	7/1	-	P4021	
			84.95	+0.01	8604DB			850XSY	CW20	WP052	7/1			
			84.96	+0.02	8604DC			850XSY	CW20	WP052	7/1			
			85.44	+0.5	8604D050			855XSY	CW20	WP052	7/1			
			85.94	+1.0	8604D100			860XSY-3	CW20	WP052	7/1			
			86.44	+1.5	8604D150			865XSY-3	CW20	WP052	7/1			
			86.94	+2.0	8604D200			870XSY-3	CW20	WP052	7/1			
			87.44	+2.5	8604D250			875XSY-3	CW20	WP052	7/1			
			87.94	+3.0	8604D300			880XSY	CW20	WP052	7/1			
			88.94	+4.0	8604D400			890XSY	CW20	WP052	7/1			
TRX400EX 12.5:1	99-08	397	84.94	Std.	8702DA	-	26.20	850XSY	CW20	WP052	7/1	-	P4021	
			84.95	+0.01	8702DB			850XSY	CW20	WP052	7/1			
			84.96	+0.02	8702DC			850XSY	CW20	WP052	7/1			
			85.44	+0.5	8702D050			855XSY	CW20	WP052	7/1			
			85.94	+1.0	8702D100			860XSY-3	CW20	WP052	7/1			
			86.44	+1.5	8702D150			865XSY-3	CW20	WP052	7/1			
			86.94	+2.0	8702D200			870XSY-3	CW20	WP052	7/1			
			87.44	+2.5	8702D250			875XSY-3	CW20	WP052	7/1			
			87.94	+3.0	8702D300			880XSY	CW20	WP052	7/1			
			88.94	+4.0	8702D400			890XSY	CW20	WP052	7/1			
TRX400 4x4	95-03	394	85.93	Std.	8599DA	-	25	860XSY-3	CW19	WP050	7/1	-	-	
			86.43	+0.5	8599D050			865XSY-3	CW19	WP050	7/1			
			86.93	+1.0	8599D100			870XSY-3	CW19	WP050	7/1			

## HONDA-ATV 4-stroke



Model	Years	Displ. (cc)	Piston Size (mm)	Over-sizes (mm)	Piston Kit Part No.	set includes						extra parts	
						Dome Volume (cm <sup>3</sup> )	Comp. Height (mm)	Ring Set Part No.	Clip Part No.	Pin Part No.	Price-code	Top End Gasket Kit	Wössner Connecting Rods
TRX450R	04-05	450	93.95	Std.	8609DA	-0.7	26	940XSY	CW21	WP051	7	D4009	P4022
			93.96	+0.01	8609DB			940XSY	CW21	WP051	7		
			93.97	+0.02	8609DC			940XSY	CW21	WP051	7		
TRX450R 11.5:1	04-05	450	93.95	Std.	8719DA	-	-	940XSY	CW21	WP051	7/1	D4009	P4022
			93.96	+0.01	8719DB			940XSY	CW21	WP051	7/1		
			93.97	+0.02	8719DC			940XSY	CW21	WP051	7/1		
TRX450R 13.1:1 Pro Series 2 Ring	04-05	450	93.95	Std.	8720DA	-	-	940XSY	CW21	WP051	7/1	D4009	P4022
			93.96	+0.01	8720DB			940XSY	CW21	WP051	7/1		
			93.97	+0.02	8720DC			940XSY	CW21	WP051	7/1		
TRX450R Big Bore	04-05	469	96.95	Std.	8610DA	-	26	970XSY	CW21	WP051	7/1	D4010	P4022
			96.96	+0.01	8610DB			970XSY	CW21	WP051	7/1		
			96.97	+0.02	8610DC			970XSY	CW21	WP051	7/1		
TRX450R 12:1	06-09	450	95.95	Std.	8660DA	-0.2	23.80	960XSY	CW19	WP037	7/1	D4011	P4023
			95.96	+0.01	8660DB			960XSY	CW19	WP037	7/1		
			95.97	+0.02	8660DC			960XSY	CW19	WP037	7/1		
			97.95	+2.0	8660D200			980XSY	CW19	WP037	7/1		
			99.95	+4.0	8660D400			1000XSY	CW19	WP037	7/1		
TRX450R 13.5:1 Pro Series 2 Ring	06-09	450	95.95	Std.	8674DA	-	23.80	960ADS-2	CW19	WP037	7	D4011	P4023
			95.96	+0.01	8674DB			960ADS-2	CW19	WP037	7		
			95.97	+0.02	8674DC			960ADS-2	CW19	WP037	7		







## HUSABERG 4-stroke



Model	Years	Displ. (cc)	Piston Size (mm)	Over-sizes (mm)	Piston Kit Part No.	Dome Volume (cm <sup>3</sup> )	Comp. Height (mm)	set includes				extra parts	
								Ring Set Part No.	Clip Part No.	Pin Part No.	Price-code	Top End Gasket Kit	Wössner Connecting Rods
FC, FE350	89-96	350	85.95	Std.	8517DA	-	23	860XSY-3	CW18	WP031	7/1	-	-
			85.96	+0.01	8517DB			860XSY-3	CW18	WP031	7/1		
			85.97	+0.02	8517DC			860XSY-3	CW18	WP031	7/1		
FC, FE400	96-05	397	91.95	Std.	8519DA	-	22.60	920XSY-3	CW18	WP031	7/1	-	-
			91.96	+0.01	8519DB			920XSY-3	CW18	WP031	7/1		
			91.97	+0.02	8519DC			920XSY-3	CW18	WP031	7/1		
FC, FE450	04-08	450	99.95	Std.	8593DA	-	24.30	1000XSY	CW20	WP038	7/1	-	-
			99.96	+0.01	8593DB			1000XSY	CW20	WP038	7/1		
			99.97	+0.02	8593DC			1000XSY	CW20	WP038	7/1		
			100.45	+0.5	8593D050			1005XSY	CW20	WP038	7/1		
			100.95	+1.0	8593D100			1010XSY-3	CW20	WP038	7/1		
FC, FE, FX 450	09	449	94,5	Std.	8707DA	-1.9	22.80	950ADS-2	CW19	WP037	7	-	-
			94,96	+0.01	8707DB			950ADS-2	CW19	WP037	7		
			94,97	+0.02	8707DC			950ADS-2	CW19	WP037	7		
FC, FX470	00-02	470	99.95	Std.	8552DA	-	22.60	1000ADS	CW20	WP038	7/1	-	-
			99.96	+0.01	8552DB			1000ADS	CW20	WP038	7/1		
			99.97	+0.02	8552DC			1000ADS	CW20	WP038	7/1		
FC, FE501	89-93	500	91.95	Std.	8516DA	-	23	920XSY-3	CW20	WP038	7/1	-	-
			91.96	+0.01	8516DB			920XSY-3	CW20	WP038	7/1		
			91.97	+0.02	8516DC			920XSY-3	CW20	WP038	7/1		
FC, FE501	94-09	500	94.95	Std.	8537DA	-	23	950XSY	CW20	WP038	7/1	-	-
			94.96	+0.01	8537DB			950XSY	CW20	WP038	7/1		
			94.97	+0.02	8537DC			950XSY	CW20	WP038	7/1		
FC, FE550	04-09	550	99.95	Std.	8602DA	-	23.40	1000XSY	CW20	WP038	7/1	-	-
			99.96	+0.01	8602DB			1000XSY	CW20	WP038	7/1		
			99.97	+0.02	8602DC			1000XSY	CW20	WP038	7/1		
FC, FE650 & 550	03-09	550	99.95	Std.	8551DA	-	23	1000XSY	CW20	WP038	7	-	-
			99.96	+0.01	8551DB			1000XSY	CW20	WP038	7		
			99.97	+0.02	8551DC			1000XSY	CW20	WP038	7		
FE570	09	-	99.95	Std.	8737DA	-10.5	24.5	1000XSY	CW20	WP038	7	-	-
			99.96	+0.01	8737DB			1000XSY	CW20	WP038	7		
			99.97	+0.02	8737DC			1000XSY	CW20	WP038	7		

## HUSABERG 4-stroke





					set includes							extra parts	
													
Model	Years	Displ. (cc)	Piston Size (mm)	Over-sizes (mm)	Piston Kit Part No.	Dome Volume (cm <sup>3</sup> )	Comp. Height (mm)	Ring Set Part No.	Clip Part No.	Pin Part No.	Price-code	Top End Gasket Kit	Wössner Connecting Rods
FC, FE600	89-00	600	94.95	Std.	8537DA	-	23	950XSY	CW20	WP038	7/1	-	-
			94.96	+0.01	8537DB			950XSY	CW20	WP038	7/1		
			94.97	+0.02	8537DC			950XSY	CW20	WP038	7/1		
FC, FE601	94-98	600	94.95	Std.	8537DA	-	23	950XSY	CW20	WP038	7/1	-	-
			94.96	+0.01	8537DB			950XSY	CW20	WP038	7/1		
			94.97	+0.02	8537DC			950XSY	CW20	WP038	7/1		
			97.95	+3.0	8537D300			980XSY	CW20	WP038	7/1		
			99.95	+5.0	8551DA			1000XSY	CW20	WP038	7		
			99.96	+5.01	8551DB			1000XSY	CW20	WP038	7		
99.97	+5.02	8551DC	1000XSY	CW20	WP038	7							
FE, FS, FX650	00-09	650	99.95	Std.	8551DA	-	23	1000XSY	CW20	WP038	7	-	-
			99.96	+0.01	8551DB			1000XSY	CW20	WP038	7		
			99.97	+0.02	8551DC			1000XSY	CW20	WP038	7		



## HUSABERG-ATV 4-stroke



					set includes							extra parts		
														
Model	Years	Displ. (cc)	Piston Size (mm)	Over-sizes (mm)	Piston Kit Part No.	Dome Volume (cm <sup>3</sup> )	Comp. Height (mm)	Ring Set Part No.	Clip Part No.	Pin Part No.	Price-code	Top End Gasket Kit	Wössner Connecting Rods	
EF & EFE400	99-00	397	91.95	Std.	8519DA	-	22.60	920XSY-3	CW18	WP031	7/1	-	-	
			91.96	+0.01	8519DB			920XSY-3	CW18	WP031	7/1			
			91.97	+0.02	8519DC			920XSY-3	CW18	WP031	7/1			
EF & EFE501	99-00	500	94.95	Std.	8537DA	-	23	950XSY	CW20	WP038	7/1	-	-	
			94.96	+0.01	8537DB			950XSY	CW20	WP038	7/1			
			94.97	+0.02	8537DC			950XSY	CW20	WP038	7/1			
EF & EFE600	99-00	600	94.95	Std.	8537DA	-	23	950XSY	CW20	WP038	7/1	-	-	
			94.96	+0.01	8537DB			950XSY	CW20	WP038	7/1			
			94.97	+0.02	8537DC			950XSY	CW20	WP038	7/1			





## HUSQVARNA 2-stroke



Model	Years	Displ. (cc)	Piston Size (mm)	Over-sizes (mm)	Piston Kit Part No.	Dome Volume (cm <sup>3</sup> )	Comp. Height (mm)	set includes				extra parts	
								Ring Set Part No.	Clip Part No.	Pin Part No.	Price-code	Top End Gasket Kit	Wössner Connecting Rods
CR & WR125	76-83	124	55.69	+0.75	8035D075	-	-	RSB5575	CW15	WP032	2/1	-	-
			55.94	+1.0	8035D100			RSB5600	CW15	WP032	2/1		
			56.44	+1.5	8035D150			RSB5650	CW15	WP032	2/1		
CR & WR125	84-87	124	54.94	Std.	8173DA	-	-	RSB5500	CW15	WP032	2/1	-	-
			54.95	+0.01	8173DB			RSB5500	CW15	WP032	2/1		
			54.96	+0.02	8173DC			RSB5500	CW15	WP032	2/1		
			55.44	+0.5	8173D050			RSB5550	CW15	WP032	2/1		
			55.69	+0.75	8173D075			RSB5575	CW15	WP032	2/1		
			55.94	+1.0	8173D100			RSB5600	CW15	WP032	2/1		
56.44	+1.5	8173D150	RSB5650	CW15	WP032	2/1							
WMX & WR125 with Dome	88-91	124	55.95	Std.	8060DA	-	-	RDB5600	CW16	WP036	2/1	-	-
			55.96	+0.01	8060DB			RDB5600	CW16	WP036	2/1		
			55.97	+0.02	8060DC			RDB5600	CW16	WP036	2/1		
			56.45	+0.5	8060D050			RDB5650	CW16	WP036	2/1		
			56.95	+1.0	8060D100			RDB5700	CW16	WP036	2/1		
CR & WR125	92-94	124	55.95	Std.	8040DA	-	25	RDB5600	CW16	WP036	2	-	-
			55.96	+0.01	8040DB			RDB5600	CW16	WP036	2		
			55.97	+0.02	8040DC			RDB5600	CW16	WP036	2		
			56.45	+0.5	8040D050			RDB5650	CW16	WP036	2		
			56.95	+1.0	8040D100			RDB5700	CW16	WP036	2		
CR & WR & SM & SMS & WRE125	97-09	125	53.95	Std.	8089DA	-	28	RSB5400	CW15	WP032	2	D2010	-
			53.96	+0.01	8089DB			RSB5400	CW15	WP032	2		
			53.97	+0.02	8089DC			RSB5400	CW15	WP032	2		
			53.98	+0.03	8089DD			RSB5400	CW15	WP032	2		
			54.45	+0.5	8089D050			RSB5450	CW15	WP032	2		
			54.95	+1.0	8089D100			RSB5500	CW15	WP032	2		
A8 & W8 125	all	125	55.94	Std.	8142DA	-	29.90	RDB5600	CW16	WP036	2/1	-	-
			56.19	+0.25	8142D025			RDB5625	CW16	WP036	2/1		
			56.44	+0.5	8142D050			RDB5650	CW16	WP036	2/1		
			56.69	+0.75	8142D075			RDB5675	CW16	WP036	2/1		
			56.94	+1.0	8142D100			RDB5700	CW16	WP036	2/1		
			57.19	+1.25	8142D125			RDB5725	CW16	WP036	2/1		
57.44	+1.5	8142D150	RDB5750	CW16	WP036	2/1							

## HUSQVARNA 2-stroke



					set includes							extra parts		
Model	Years	Displ. (cc)	Piston Size (mm)	Over-sizes (mm)	Piston Kit Part No.	Dome Volume (cm <sup>3</sup> )	Comp. Height (mm)	Ring Set Part No.	Clip Part No.	Pin Part No.	Price-code	Top End Gasket Kit	Wössner Connecting Rods	
CR & WR240	87-88	240	67.44	+1.0	8044D100	-	35	RSB6750	CW18	WP033	3/1	-	-	
			67.94	+1.5	8044D150			RSB6800	CW18	WP033	3/1			
CR & WR & XR250	74-84	249	69.44	Std.	8004DA	-	32	RDB6950	CW18	WP033	3/1	-	-	
			69.45	+0.01	8004DB			RDB6950	CW18	WP033	3/1			
			69.46	+0.02	8004DC			RDB6950	CW18	WP033	3/1			
			69.94	+0.5	8004D050			RDB7000	CW18	WP033	3/1			
			70.44	+1.0	8004D100			RDB7050	CW18	WP033	3/1			
			70.94	+1.5	8004D150			RDB7100	CW18	WP033	3/1			
			71.44	+2.0	8004D200			RDB7150	CW18	WP033	3/1			
CR & WR250	85-86	249	69.44	Std.	8010DA	-	32	RDB6950	CW18	WP033	3/1	-	-	
			69.45	+0.01	8010DB			RDB6950	CW18	WP033	3/1			
			69.46	+0.02	8010DC			RDB6950	CW18	WP033	3/1			
			69.94	+0.5	8010D050			RDB7000	CW18	WP033	3/1			
			70.44	+1.0	8010D100			RDB7050	CW18	WP033	3/1			
			70.94	+1.5	8010D150			RDB7100	CW18	WP033	3/1			
			71.44	+2.0	8010D200			RDB7150	CW18	WP033	3/1			
CR & WR250	87-91	249	69.94	Std.	8199DA	-	30	RDB7000	CW18	WP033	3/1	-	-	
			69.95	+0.01	8199DB			RDB7000	CW18	WP033	3/1			
			69.96	+0.02	8199DC			RDB7000	CW18	WP033	3/1			
			69.97	+0.03	8199DD			RDB7000	CW18	WP033	3/1			
CR & WR250	92-98	249	66.94	Std.	8015DA	-	35	RDB6700	CW18	WP033	3	-	-	
			66.95	+0.01	8015DB			RDB6700	CW18	WP033	3			
			66.96	+0.02	8015DC			RDB6700	CW18	WP033	3			
			67.44	+0.5	8015D050			RDB6750	CW18	WP033	3			
			67.94	+1.0	8015D100			RDB6800	CW18	WP033	3			
CR & WR250	99-09	249	66.34	Std.	8141DA	-	38	RDB6640	CW18	WP033	3	-	-	
			66.35	+0.01	8141DB			RDB6640	CW18	WP033	3			
			66.36	+0.02	8141DC			RDB6640	CW18	WP033	3			
CR & WR360	92-02	360	77.94	Std.	8076DA	-	27	RDC7800	CA18	WP039	6/1	-	-	
			77.95	+0.01	8076DB			RDC7800	CA18	WP039	6/1			
			77.96	+0.02	8076DC			RDC7800	CA18	WP039	6/1			
			78.44	+0.5	8076D050			RDC7850	CA18	WP039	6/1			

## HUSQVARNA 2-stroke



Model	Years	Displ. (cc)	Piston Size (mm)	Over-sizes (mm)	Piston Kit Part No.	Dome Volume (cm <sup>3</sup> )	Comp. Height (mm)	set includes				extra parts	
								Ring Set Part No.	Clip Part No.	Pin Part No.	Price-code	Top End Gasket Kit	Wössner Connecting Rods
CR & WR390 KH37mm	77-80	390	82.92	Std.	8033DA	-	37	RSC8300	CW18	WP033	6/1	-	-
			83.42	+0.5	8033D050			RSC8350	CW18	WP033	6/1		
			83.92	+1.0	8033D100			RSC8400	CW18	WP033	6/1		
			84.42	+1.5	8033D150			RSC8450	CW18	WP033	6/1		
			84.92	+2.0	8033D200			RSC8500	CW18	WP033	6/1		
			85.42	+2.5	8033D250			RSC8550	CW18	WP033	6/1		
CR & WR390 KH35mm	77-80	390	82.92	Std.	8249DA	-	-	RSC8300	CW18	WP033	6	-	-
			83.42	+0.5	8249D050			RSC8350	CW18	WP033	6		
			83.92	+1.0	8249D100			RSC8400	CW18	WP033	6		
			84.42	+1.5	8249D150			RSC8450	CW18	WP033	6		
			84.92	+2.0	8249D200			RSC8500	CW18	WP033	6		
			85.42	+2.5	8249D250			RSC8550	CW18	WP033	6		
WR430	84-88	-	85.92	Std.	8051DA	-	37	RSC8600	CW18	WP039	6/1	-	-
			85.93	+0.01	8051DB			RSC8600	CW18	WP039	6/1		
			85.94	+0.02	8051DC			RSC8600	CW18	WP039	6/1		
			86.42	+0.5	8051D050			RSC8650	CW18	WP039	6/1		
			86.92	+1.0	8051D100			RSC8700	CW18	WP039	6/1		
			87.42	+1.5	8051D150			RSC8750	CW18	WP039	6/1		
CR500	83-87	500	86.92	+1.0	8037D100	-	42	RSC8700	CW20	WP086	6/1	-	-
			87.42	+1.5	8037D150			RSC8750	CW20	WP086	6/1		
			87.92	+2.0	8037D200			RSC8800	CW20	WP086	6/1		

## HUSQVARNA 4-stroke



Model	Years	Displ. (cc)	Piston Size (mm)	Over-sizes (mm)	Piston Kit Part No.	set includes						extra parts	
						Dome Volume (cm <sup>3</sup> )	Comp. Height (mm)	Ring Set Part No.	Clip Part No.	Pin Part No.	Price-code	Top End Gasket Kit	Wössner Connecting Rods
TC & TE250 12.9:1	02-05	249	75.96	Std.	8576DA	-	23.50	760XAS-2	CW16	WP059	5	-	-
			75.97	+0.01	8576DB			760XAS-2	CW16	WP059	5		
			75.98	+0.02	8576DC			760XAS-2	CW16	WP059	5		
TC & TE250 13:1	06-09	249	75.96	Std.	8650DA	-	-	760XAS-2	CW16	WP059	5	-	-
			75.97	+0.01	8650DB			760XAS-2	CW16	WP059	5		
			75.98	+0.02	8650DC			760XAS-2	CW16	WP059	5		
TC250 14:1	09	249	78.95	Std.	8770DA	-	-	790XAS	CW16	WP059	7/1	-	-
			78.96	+0.01	8770DB			790XAS	CW16	WP059	7/1		
			78.97	+0.02	8770DC			790XAS	CW16	WP059	7/1		
TC310 13:1	09	297	82.95	Std.	8771DA	-	-	830XSY	CW16	WP059	7/1	-	-
			82.96	+0.01	8771DB			830XSY	CW16	WP059	7/1		
			82.97	+0.02	8771DC			830XSY	CW16	WP059	7/1		
TE350	90-97	349	83.94	Std.	8510DA	-	28	840XSY-3	CW20	WP029	7/1	-	-
			83.95	+0.01	8510DB			840XSY-3	CW20	WP029	7/1		
			83.96	+0.02	8510DC			840XSY-3	CW20	WP029	7/1		
TE & SMR400	01-03	400	91.44	Std.	8550DA	-	-	915XSY	CW20	WP038	7/1	-	-
			91.45	+0.01	8550DB			915XSY	CW20	WP038	7/1		
			91.46	+0.02	8550DC			915XSY	CW20	WP038	7/1		
TE410	93-95	414	91.44	Std.	8515DA	-	27.80	915XSY	CW20	WP038	7/1	-	-
			91.45	+0.01	8515DB			915XSY	CW20	WP038	7/1		
			91.46	+0.02	8515DC			915XSY	CW20	WP038	7/1		
TE410	96-98	399	91.44	Std.	8514DA	-	29.50	915XSY	CW20	WP038	7/1	-	-
			91.45	+0.01	8514DB			915XSY	CW20	WP038	7/1		
			91.46	+0.02	8514DC			915XSY	CW20	WP038	7/1		
TE410	99-01	414	91.44	Std.	8518DA	-	24.50	915XSY	CW20	WP038	7/1	-	-
			91.45	+0.01	8518DB			915XSY	CW20	WP038	7/1		
			91.46	+0.02	8518DC			915XSY	CW20	WP038	7/1		
TC & SMR450	02	449	96.94	Std.	8556DA	-	24.50	970XSY	CW20	WP038	7/1	-	-
			96.95	+0.01	8556DB			970XSY	CW20	WP038	7/1		
			96.96	+0.02	8556DC			970XSY	CW20	WP038	7/1		





## HUSQVARNA 4-stroke



Model	Years	Displ. (cc)	Piston Size (mm)	Over-sizes (mm)	Piston Kit Part No.	Dome Volume (cm <sup>3</sup> )	Comp. Height (mm)	set includes				extra parts	
								Ring Set Part No.	Clip Part No.	Pin Part No.	Price-code	Top End Gasket Kit	Wössner Connecting Rods
TC & TE & SMR450	03-05	449	96.94	Std.	8578DA	-6.5	24.50	970XSY	CW20	WP038	7	-	-
			96.95	+0.01	8578DB			970XSY	CW20	WP038	7		
			96.96	+0.02	8578DC			970XSY	CW20	WP038	7		
TC & TE & SMR450 13:1	06-09	449	96.96	Std.	8651DA	-	-	970XSY	CW20	WP038	7	-	-
			96.97	+0.01	8651DB			970XSY	CW20	WP038	7		
			96.98	+0.02	8651DC			970XSY	CW20	WP038	7		
TE & TC & WRE510	87-90	499	91.44	Std.	8511DA	-	30	915XSY	CW20	WP038	7/1	-	-
			91.45	+0.01	8511DB			915XSY	CW20	WP038	7/1		
			91.46	+0.02	8511DC			915XSY	CW20	WP038	7/1		
			91.94	+0.5	8511D050			920XSY-3	CW20	WP038	7/1		
TC & TE510 13:1	06-09	501	96.95	Std.	8652DA	-9.2	24.80	970XSY	CW20	WP038	7/1	-	-
			96.96	+0.01	8652DB			970XSY	CW20	WP038	7/1		
			96.97	+0.02	8652DC			970XSY	CW20	WP038	7/1		
TC & TE570	01-02	577	97.94	Std.	8526DA	-5.4	25	980XSY	CW22	WP009	7	-	-
			97.95	+0.01	8526DB			980XSY	CW22	WP009	7		
			97.96	+0.02	8526DC			980XSY	CW22	WP009	7		
			99.94	+2.0	8526D200			1000XSY	CW22	WP009	7		
TC & TE610	91-98	600	97.94	Std.	8522DA	-1.8	30	980XSY-3	CW22	WP009	7	D4012	-
			97.95	+0.01	8522DB			980XSY-3	CW22	WP009	7		
			97.96	+0.02	8522DC			980XSY-3	CW22	WP009	7		
			99.94	+2.0	8522D200			1000XSY-3	CW22	WP009	7		
			101.94	+4.0	8522D400			1020XSU	CW22	WP009	7		
TC & TE610	99-03	600	97.94	Std.	8526DA	-5.4	25	980XSY	CW22	WP009	7	D4012	-
			97.95	+0.01	8526DB			980XSY	CW22	WP009	7		
			97.96	+0.02	8526DC			980XSY	CW22	WP009	7		
			99.94	+2.0	8526D200			1000XSY	CW22	WP009	7		
			100.94	+3.0	8526D300			1010XSY-3	CW22	WP009	7		
			101.94	+4.0	8526D400			1020XSU-3	CW22	WP009	7		
TC & TE610 Hi-Compr.	99-03	600	97.94	Std.	8568DA	+8.2	25	980XSY	CW22	WP009	7/1	D4012	-
			97.95	+0.01	8568DB			980XSY	CW22	WP009	7/1		
			97.96	+0.02	8568DC			980XSY	CW22	WP009	7/1		
			99.94	+2.0	8568D200			1000XSY	CW22	WP009	7/1		

## KAWASAKI 2-stroke



					set includes							extra parts	
													
Model	Years	Displ. (cc)	Piston Size (mm)	Over-sizes (mm)	Piston Kit Part No.	Dome Volume (cm <sup>3</sup> )	Comp. Height (mm)	Ring Set Part No.	Clip Part No.	Pin Part No.	Price-code	Top End Gasket Kit	Wössner Connecting Rods
KX60	83-03	60	42.95	Std.	8232DA	-	24	RSB4300	CW12	WP091	1/1	-	P2001
			43.45	+0.5	8232D050			RSB4350	CW12	WP091	1/1		
			43.95	+1.0	8232D100			RSB4400	CW12	WP091	1/1		
			44.95	+2.0	8232D200			RSB4500	CW12	WP091	1/1		
KX65	00-09	65	44.45	Std.	8196DA	-	23.60	RSB4450	CW12	WP091	1	D2011	P2001
			44.46	+0.01	8196DB			RSB4450	CW12	WP091	1		
			44.47	+0.02	8196DC			RSB4450	CW12	WP091	1		
			44.48	+0.03	8196DD			RSB4450	CW12	WP091	1		
KX80	82-83	82	47.95	Std.	8200DA	-	-	RSB4800	CW14	WP058	1/1	-	P2036
			48.45	+0.5	8200D050			RSB4850	CW14	WP058	1/1		
			48.95	+1.0	8200D100			RSB4900	CW14	WP058	1/1		
KX80	84-85	82	47.95	Std.	8201DA	-	-	RSB4800	CW14	WP058	1/1	-	P2036
			48.45	+0.5	8201D050			RSB4850	CW14	WP058	1/1		
			48.95	+1.0	8201D100			RSB4900	CW14	WP058	1/1		
KX80 U.S Bore	88-00	82	47.95	Std.	8197DA	-	26	RSB4800	CW14	WP058	1/1	-	P2005
			47.96	+0.01	8197DB			RSB4800	CW14	WP058	1/1		
			47.97	+0.02	8197DC			RSB4800	CW14	WP058	1/1		
			47.98	+0.03	8197DD			RSB4800	CW14	WP058	1/1		
			48.45	+0.5	8197D050			RSB4850	CW14	WP058	1/1		
			48.95	+1.0	8197D100			RSB4900	CW14	WP058	1/1		
			51.95	+4.0	8197D400			RSB5200	CW14	WP058	1/1		
			52.45	+4.5	8197D450			RSB5250	CW14	WP058	1/1		
52.95	+5.0	8197D500	RSB5300	CW14	WP058	1/1							
KX80 International Bore	88-00	79	46.95	Std.	8234DA	-	26	RSB4700	CW14	WP058	1	D2012	P2005
			46.96	+0.01	8234DB			RSB4700	CW14	WP058	1		
			46.97	+0.02	8234DC			RSB4700	CW14	WP058	1		
KX85	01-09	85	48.45	Std.	8102DA	-	26	RSB4850	CW14	WP058	1	-	P2005
			48.46	+0.01	8102DB			RSB4850	CW14	WP058	1		
			48.47	+0.02	8102DC			RSB4850	CW14	WP058	1		
			51.95	+3.5	8102D350			RSB5200	CW14	WP058	1		
			52.45	+4.0	8102D400			RSB5250	CW14	WP058	1		
			52.95	+4.5	8102D450			RSB5300	CW14	WP058	1		

## KAWASAKI 2-stroke



Model	Years	Displ. (cc)	Piston Size (mm)	Over-sizes (mm)	Piston Kit Part No.	Dome Volume (cm <sup>3</sup> )	Comp. Height (mm)	set includes				extra parts	
								Ring Set Part No.	Clip Part No.	Pin Part No.	Price-code	Top End Gasket Kit	Wössner Connecting Rods
KX100	98-10	-	52.45	Std.	8254DA	-	26	RSB5250	CW14	WP025	1	-	P2005
			52.95	+0.5	8254D050			RSB5300	CW14	WP025	1		
			53.45	+1.0	8254D100			RSB5350	CW14	WP025	1		
			53.95	+1.5	8254D150			RSB5400	CW14	WP025	1		
			54.45	+2.0	8254D200			RSB5450	CW14	WP025	1		
KX125	78-81	125	55.94	Std.	8202DA	-	-	RDB5600	CW16	WP036	2/1	-	P2037
			56.44	+0.5	8202D050			RDB5650	CW16	WP036	2/1		
			56.94	+1.0	8202D100			RDB5700	CW16	WP036	2/1		
KX125	82-85	125	55.94	Std.	8210DA	-	29.70	RDB5600	CW16	WP036	2/1	-	P2037
			55.95	+0.01	8210DB			RDB5600	CW16	WP036	2/1		
			55.96	+0.02	8210DC			RDB5600	CW16	WP036	2/1		
			56.44	+0.5	8210D050			RDB5650	CW16	WP036	2/1		
			56.94	+1.0	8210D100			RDB5700	CW16	WP036	2/1		
KX125	86	125	55.94	Std.	8211DA	-	29.70	RSB5600	CW16	WP036	2/1	-	P2037
			55.95	+0.01	8211DB			RSB5600	CW16	WP036	2/1		
			55.96	+0.02	8211DC			RSB5600	CW16	WP036	2/1		
			56.44	+0.5	8211D050			RSB5650	CW16	WP036	2/1		
			56.94	+1.0	8211D100			RSB5700	CW16	WP036	2/1		
KX125	87	125	55.94	Std.	8128DA	-	29.50	RSB5600	CW16	WP036	2/1	-	P2037
			55.95	+0.01	8128DB			RSB5600	CW16	WP036	2/1		
			55.96	+0.02	8128DC			RSB5600	CW16	WP036	2/1		
			56.44	+0.5	8128D050			RSB5650	CW16	WP036	2/1		
			56.94	+1.0	8128D100			RSB5700	CW16	WP036	2/1		
			57.44	+1.5	8128D150			RSB5750	CW16	WP036	2/1		
			57.94	+2.0	8128D200			RSB5800	CW16	WP036	2/1		
KX125	88-89	125	55.94	Std.	8130DA	-	29.50	RSB5600	CW16	WP036	2	-	P2033
			55.95	+0.01	8130DB			RSB5600	CW16	WP036	2		
			55.96	+0.02	8130DC			RSB5600	CW16	WP036	2		
			56.44	+0.5	8130D050			RSB5650	CW16	WP036	2		
			56.94	+1.0	8130D100			RSB5700	CW16	WP036	2		

## KAWASAKI 2-stroke





Model	Years	Displ. (cc)	Piston Size (mm)	Over-sizes (mm)	Piston Kit Part No.	Dome Volume (cm <sup>3</sup> )	Comp. Height (mm)	set includes				extra parts	
								Ring Set Part No.	Clip Part No.	Pin Part No.	Price-code	Top End Gasket Kit	Wössner Connecting Rods
KX125	90	125	55.94	Std.	8106DA	-	29.50	RSB5600	CW16	WP036	2	-	P2033
			55.95	+0.01	8106DB			RSB5600	CW16	WP036	2		
			56.44	+0.5	8106D050			RSB5650	CW16	WP036	2		
			56.94	+1.0	8106D100			RSB5700	CW16	WP036	2		
KX125	91	125	55.94	Std.	8108DA	-	29.50	RSB5600	CW16	WP036	2	-	P2033
			55.95	+0.01	8108DB			RSB5600	CW16	WP036	2		
			56.44	+0.5	8108D050			RSB5650	CW16	WP036	2		
			56.94	+1.0	8108D100			RSB5700	CW16	WP036	2		
KX125	92-93	125	53.94	Std.	8110DA	-	29	RSB5400	CW16	WP036	2	-	P2037
			53.95	+0.01	8110DB			RSB5400	CW16	WP036	2		
			53.96	+0.02	8110DC			RSB5400	CW16	WP036	2		
			54.44	+0.5	8110D050			RSB5450	CW16	WP036	2		
			54.94	+1.0	8110D100			RSB5500	CW16	WP036	2		
KX125	94	125	53.94	Std.	8111DA	-	29.50	RSB5400	CW15	WP032	2/1	-	P2038
			53.95	+0.01	8111DB			RSB5400	CW15	WP032	2/1		
			53.96	+0.02	8111DC			RSB5400	CW15	WP032	2/1		
			54.44	+0.5	8111D050			RSB5450	CW15	WP032	2/1		
			54.94	+1.0	8111D100			RSB5500	CW15	WP032	2/1		
KX125	95-97	125	53.94	Std.	8112DA	-	29.50	RSB5400	CW15	WP032	2	-	P2038
			53.95	+0.01	8112DB			RSB5400	CW15	WP032	2		
			53.96	+0.02	8112DC			RSB5400	CW15	WP032	2		
			54.44	+0.5	8112D050			RSB5450	CW15	WP032	2		
			54.94	+1.0	8112D100			RSB5500	CW15	WP032	2		
			55.94	+2.0	8112D200			RSB5600	CW15	WP032	2		
KX125	98	125	53.94	Std.	8113DA	-	29.50	RSB5400	CW15	WP032	2/1	-	P2034
			53.95	+0.01	8113DB			RSB5400	CW15	WP032	2/1		
			53.96	+0.02	8113DC			RSB5400	CW15	WP032	2/1		
			55.94	+2.0	8113D200			RSB5600	CW15	WP032	2/1		
KX125	99-00	125	53.95	Std.	8057DA	-	29.30	RSB5400	CW15	WP032	2	-	P2034
			53.96	+0.01	8057DB			RSB5400	CW15	WP032	2		
			53.97	+0.02	8057DC			RSB5400	CW15	WP032	2		
			55.95	+2.0	8057D200			RSB5600	CW15	WP032	2		



## KAWASAKI 2-stroke

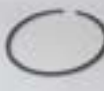

					set includes							extra parts	
													
Model	Years	Displ. (cc)	Piston Size (mm)	Over-sizes (mm)	Piston Kit Part No.	Dome Volume (cm <sup>3</sup> )	Comp. Height (mm)	Ring Set Part No.	Clip Part No.	Pin Part No.	Price-code	Top End Gasket Kit	Wössner Connecting Rods
KX125	01-02	125	53.95	Std.	8062DA	-	29.30	RSB5400	CW15	WP032	2	-	P2034
			53.96	+0.01	8062DB			RSB5400	CW15	WP032	2		
			53.97	+0.02	8062DC			RSB5400	CW15	WP032	2		
			55.95	+2.0	8062D200			RSB5600	CW15	WP032	2		
KX125	03	125	53.95	Std.	8073DA	-	29.30	RSB5400	CW15	WP032	2	D2013	P2010
			53.96	+0.01	8073DB			RSB5400	CW15	WP032	2		
			53.97	+0.02	8073DC			RSB5400	CW15	WP032	2		
			55.95	+2.0	8073D200			RSB5600	CW15	WP032	2		
KX125	04-09	125	53.95	Std.	8167DA	-	-	RSB5400	CW15	WP032	2	D2013	P2010
			53.96	+0.01	8167DB			RSB5400	CW15	WP032	2		
			53.97	+0.02	8167DC			RSB5400	CW15	WP032	2		
			55.95	+2.0	8167D200			RSB5600	CW15	WP032	2		
KMX125	86-05	125	53.94	Std.	8007DA	-	32.80	RDB5400	CW16	WP036	2	-	-
			53.95	+0.01	8007DB			RDB5400	CW16	WP036	2		
			53.96	+0.02	8007DC			RDB5400	CW16	WP036	2		
			54.44	+0.5	8007D050			RDB5450	CW16	WP036	2		
			54.94	+1.0	8007D100			RDB5500	CW16	WP036	2		
			55.94	+2.0	8007D200			RDB5600	CW16	WP036	2		
KDX125	90-05	125	55.94	Std.	8008DA	-	29.50	RDB5600	CW16	WP036	2	-	-
			55.95	+0.01	8008DB			RDB5600	CW16	WP036	2		
			55.96	+0.02	8008DC			RDB5600	CW16	WP036	2		
			56.44	+0.5	8008D050			RDB5650	CW16	WP036	2		
			56.94	+1.0	8008D100			RDB5700	CW16	WP036	2		
KD & KE & KS125	74-84	125	55.94	Std.	8032DA	-	34	RDB5600	CW14	WP025	2	-	-
			56.44	+0.5	8032D050			RDB5650	CW14	WP025	2		
			56.94	+1.0	8032D100			RDB5700	CW14	WP025	2		
			57.44	+1.5	8032D150			RDB5750	CW14	WP025	2		
			57.94	+2.0	8032D200			RDB5800	CW14	WP025	2		





## KAWASAKI 2-stroke



Model	Years	Displ. (cc)	Piston Size (mm)	Over-sizes (mm)	Piston Kit Part No.	Dome Volume (cm <sup>3</sup> )	Comp. Height (mm)	set includes					extra parts	
								Ring Set Part No.	Clip Part No.	Pin Part No.	Price-code	Top End Gasket Kit	Wössner Connecting Rods	
KDX200	86-09	198	65.94	Std.	8093DA	-	32	RDB6600	CW16	WP027	3	-	P2033	
			65.95	+0.01	8093DB			RDB6600	CW16	WP027	3			
			65.96	+0.02	8093DC			RDB6600	CW16	WP027	3			
			66.44	+0.5	8093D050			RDB6650	CW16	WP027	3			
			66.94	+1.0	8093D100			RDB6700	CW16	WP027	3			
KDX220	98-05	216	68.94	Std.	8092DA	-	32	RDB6900	CW16	WP027	3	-	P2033	
			68.95	+0.01	8092DB			RDB6900	CW16	WP027	3			
			68.96	+0.02	8092DC			RDB6900	CW16	WP027	3			
KDX250	80-84	249	69.94	Std.	8203DA	-	31.50	RDB7000	CW18	WP033	3/1	-	-	
			70.44	+0.5	8203D050			RDB7050	CW18	WP033	3/1			
			70.94	+1.0	8203D100			RDB7100	CW18	WP033	3/1			
			71.44	+1.5	8203D150			RDB7150	CW18	WP033	3/1			
			71.94	+2.0	8203D200			RDB7200	CW18	WP033	3/1			
KR1 250	89-93	249	55.94	Std.	8043DA	-	29.50	RDB5600	CW16	WP036	2	-	-	
			56.44	+0.5	8043D050			RDB5650	CW16	WP036	2			
KX250	80-84	249	69.94	Std.	8203DA	-	31.50	RDB7000	CW18	WP033	3/1	-	-	
			70.44	+0.5	8203D050			RDB7050	CW18	WP033	3/1			
			70.94	+1.0	8203D100			RDB7100	CW18	WP033	3/1			
			71.44	+1.5	8203D150			RDB7150	CW18	WP033	3/1			
			71.94	+2.0	8203D200			RDB7200	CW18	WP033	3/1			
KX250	87-89	249	67.34	Std.	8129DA	-	37	RDB6740	CW18	WP033	3/1	-	-	
			67.35	+0.01	8129DB			RDB6740	CW18	WP033	3/1			
			67.94	+0.6	8129D060			RDB6800	CW18	WP033	3/1			
			68.44	+1.1	8129D110			RDB6850	CW18	WP033	3/1			
			68.94	+1.6	8129D160			RDB6900	CW18	WP033	3/1			
			69.44	+2.1	8129D210			RDB6950	CW18	WP033	3/1			
KX250 & KDX250	90-91 & 91-94	250	67.34	Std.	8109DA	-	37	RDB6740	CW18	WP033	3	-	P2022	
			67.35	+0.01	8109DB			RDB6740	CW18	WP033	3			
			67.36	+0.02	8109DC			RDB6740	CW18	WP033	3			
			67.94	+0.6	8109D060			RDB6800	CW18	WP033	3			
			68.44	+1.10	8109D110			RDB6850	CW18	WP033	3			

## KAWASAKI 2-stroke



					set includes							extra parts	
													
Model	Years	Displ. (cc)	Piston Size (mm)	Over-sizes (mm)	Piston Kit Part No.	Dome Volume (cm <sup>3</sup> )	Comp. Height (mm)	Ring Set Part No.	Clip Part No.	Pin Part No.	Price-code	Top End Gasket Kit	Wössner Connecting Rods
KX250	92-01	249	66.34	Std.	8026DA	-	37	RDB6640	CW18	WP033	3	D2014	-
			66.35	+0.01	8026DB			RDB6640	CW18	WP033	3		
			66.36	+0.02	8026DC			RDB6640	CW18	WP033	3		
			66.94	+0.6	8026D060			RDB6700	CW18	WP033	3		
			67.44	+1.1	8026D110			RDB6750	CW18	WP033	3		
			67.94	+1.6	8026D160			RDB6800	CW18	WP033	3		
KX250	02-04	249	66.34	Std.	8088DA	-	37	RDB6640	CW18	WP033	3	D2014	P2022
			66.35	+0.01	8088DB			RDB6640	CW18	WP033	3		
			66.36	+0.02	8088DC			RDB6640	CW18	WP033	3		
KX250	05-09	249	66.34	Std.	8168DA	-	37	RDB6640	CW18	WP033	3	D2015	P2022
			66.35	+0.01	8168DB			RDB6640	CW18	WP033	3		
			66.36	+0.02	8168DC			RDB6640	CW18	WP033	3		
			66.37	+0.03	8168DD			RDB6640	CW18	WP033	3		
KX500	88-04	500	85.93	Std.	8228DA	-	37.50	RSC8600	CW19	WP019	6/1	-	P2039
			86.43	+0.5	8228D050			RSC8650	CW19	WP019	6/1		
			86.93	+1.0	8228D100			RSC8700	CW19	WP019	6/1		
			87.43	+1.5	8228D150			RSC8750	CW19	WP019	6/1		
			87.93	+2.0	8228D200			RSC8800	CW19	WP019	6/1		



## KAWASAKI 4-stroke



Model	Years	Displ. (cc)	Piston Size (mm)	Over-sizes (mm)	Piston Kit Part No.	Dome Volume (cm <sup>3</sup> )	Comp. Height (mm)	set includes				extra parts	
								Ring Set Part No.	Clip Part No.	Pin Part No.	Price-code	Top End Gasket Kit	Wössner Connecting Rods
KLX110	02-09	118	53.95	+1.0	8676D100	+1.7	19.70	540XKS	CW13	WP088	4/1	-	-
			54.45	+1.5	8676D150			545XKS	CW13	WP088	4/1		
			54.95	+2.0	8676D200			550XKS	CW13	WP088	4/1		
			56.95	+4.0	8676D400			570XKS	CW13	WP088	4/1		
KLX125	02-09	125	56.95	Std.	8677DA	-	19.70	570XKS	CW14	WP058	4/1	-	-
			57.45	+0.50	8677D050			575XKS	CW14	WP058	4/1		
			57.95	+1.0	8677D100			580XKS	CW14	WP058	4/1		
KX250F	04-05	249	76.96	Std.	8582DA	-5.85	19.60	770XAS-3	CW16	WP059	5	D4013	P4002
			76.97	+0.01	8582DB			770XAS-3	CW16	WP059	5		
			76.98	+0.02	8582DC			770XAS-3	CW16	WP059	5		
			82.96	+6.0	8582D600			830XSY	CW16	WP059	7		
KX250F 13.5:1	06-09	250	76.96	Std.	8635DA	-	19.60	770XAS-3	CW16	WP059	5	D4013 / D4014	P4002
			76.97	+0.01	8635DB			770XAS-3	CW16	WP059	5		
			76.98	+0.02	8635DC			770XAS-3	CW16	WP059	5		
			79.96	+3.0	8635D300			800XDS-3	CW16	WP059	5		
KX250F Pro-Series 13.9:1	06-09	250	76.96	Std.	8686DA	-3.37	19.60	770XAS-2	CW16	WP059	5	D4013 / D4014	P4002
			76.97	+0.01	8686DB			770XAS-2	CW16	WP059	5		
			76.98	+0.02	8686DC			770XAS-2	CW16	WP059	5		
KX250F	10	250	76.96	Std.	8777DA	-2.5	19.60	770XAS-2	CW16	WP070	5	-	P4002
			76.97	+0.01	8777DB			770XAS-2	CW16	WP070	5		
			76.98	+0.02	8777DC			770XAS-2	CW16	WP070	5		
KX250F 13.9:1	10	250	76.96	Std.	8778DA	-1.4	19.60	770XAS-2	CW16	WP070	5	-	P4002
			76.97	+0.01	8778DB			770XAS-2	CW16	WP070	5		
			76.98	+0.02	8778DC			770XAS-2	CW16	WP070	5		
KLX300R	97-09	290	77.94	Std.	8644DA	-	23	780XDS	CW17	WP090	5/1	-	-
			79.94	+2.0	8644D200			800XDS-3	CW17	WP090	5/1		
KLX400	03-06	398	89.94	Std.	8565DA	-	25.30	900XSY	CW20	WP029	7/1	-	P4009
			89.95	+0.01	8565DB			900XSY	CW20	WP029	7/1		
			89.96	+0.02	8565DC			900XSY	CW20	WP029	7/1		
			93.94	+4.0	8565D400			940XSY	CW20	WP029	7/1		

## KAWASAKI 4-stroke



					set includes							extra parts	
													
Model	Years	Displ. (cc)	Piston Size (mm)	Over-sizes (mm)	Piston Kit Part No.	Dome Volume (cm <sup>3</sup> )	Comp. Height (mm)	Ring Set Part No.	Clip Part No.	Pin Part No.	Price-code	Top End Gasket Kit	Wössner Connecting Rods
KLX400 Pro Series 13.5:1	03-06	398	89.94	Std.	8566DA	-	25.30	900XS	CW20	WP029	7/1	-	P4009
			89.95	+0.01	8566DB			900XS	CW20	WP029	7/1		
			89.96	+0.02	8566DC			900XS	CW20	WP029	7/1		
			95.44	+5.5	8566D550			955XS	CW20	WP029	7/1		
KX450F 12:1	05-08	449	95.95	Std.	8648DA	+0.2	23.60	960ADS-2	CW19	WP037	7	D4015	P4010
			95.96	+0.01	8648DB			960ADS-2	CW19	WP037	7		
			95.97	+0.02	8648DC			960ADS-2	CW19	WP037	7		
KX450F Pro-Series 13:1	05-08	449	95.95	Std.	8670DA	-	23.60	960ADS-2	CW19	WP037	7	D4015	P4010
			95.96	+0.01	8670DB			960ADS-2	CW19	WP037	7		
			95.97	+0.02	8670DC			960ADS-2	CW19	WP037	7		
KX450F 12.5:1	09-10	449	95.96	Std.	8738DA	+1	23.70	960ADS-2	CW19	WP071	7	D4016	P4020
			95.97	+0.01	8738DB			960ADS-2	CW19	WP071	7		
			95.98	+0.02	8738DC			960ADS-2	CW19	WP071	7		
KX450F Pro Series	09-10	449	95.96	Std.	8769DA	+4.2	-	960ADS-2	CW19	WP071	7	D4016	P4020
			95.97	+0.01	8769DB			960ADS-2	CW19	WP071	7		
			95.98	+0.02	8769DC			960ADS-2	CW19	WP071	7		
KLR600	84-87	565	96.94	+1.0	8509D100	-	31	970XS-3	CW23	WP008	7	-	-
			97.44	+1.5	8509D150			975XS-3	CW23	WP008	7		
			97.94	+2.0	8509D200			980XS-3	CW23	WP008	7		
KLX650 & KLX650R	93-95	651	99.94	Std.	8512DA	-	29.50	1000XS-3	CW24	WP057	7/1	-	-
			99.95	+0.01	8512DB			1000XS-3	CW24	WP057	7/1		
			99.96	+0.02	8512DC			1000XS-3	CW24	WP057	7/1		
			100.94	+1.0	8512D100			1010XS-3	CW24	WP057	7/1		
			101.94	+2.0	8512D200			1020XSU	CW24	WP057	7/1		
KLR650 Tengai	87-04	651	99.94	Std.	8523DA	-	31	1000XS-3	CW24	WP057	7/1	-	-
			99.95	+0.01	8523DB			1000XS-3	CW24	WP057	7/1		
			99.96	+0.02	8523DC			1000XS-3	CW24	WP057	7/1		
			100.94	+1.0	8523D100			1010XS-3	CW24	WP057	7/1		
			101.94	+2.0	8523D200			1020XSU-3	CW24	WP057	7/1		





## KAWASAKI-ATV 4-stroke



					set includes							extra parts	
Model	Years	Displ. (cc)	Piston Size (mm)	Over-sizes (mm)	Piston Kit Part No.	Dome Volume (cm <sup>3</sup> )	Comp. Height (mm)	Ring Set Part No.	Clip Part No.	Pin Part No.	Price-code	Top End Gasket Kit	Wössner Connecting Rods
KSF250 Mojave	thru 2005	249	73.94	Std.	8596DA	-	26.50	740XDS	CW18	WP031	5/1	-	-
			74.44	+0.5	8596D050			745XDS	CW18	WP031	5/1		
			74.94	+1.0	8596D100			750XDS	CW18	WP031	5/1		
KLF300 Bayou	86-03	290	75.94	Std.	8597DA	-	26.50	760XDS	CW18	WP031	5	-	-
			76.44	+0.5	8597D050			765XDS	CW18	WP031	5		
			76.94	+1.0	8597D100			770XDS	CW18	WP031	5		
KFX400 11.3:1	03-06	398	89.94	Std.	8565DA	-	25.30	900XSY	CW20	WP029	7/1	-	P4009
			89.95	+0.01	8565DB			900XSY	CW20	WP029	7/1		
			89.96	+0.02	8565DC			900XSY	CW20	WP029	7/1		
			93.94	+4.0	8565D400			940XSY	CW20	WP029	7/1		
KFX400 13.5:1 Pro Series 2 Ring	03-06	398	89.94	Std.	8566DA	-	25.30	900XSY	CW20	WP029	7/1	-	P4009
			89.95	+0.01	8566DB			900XSY	CW20	WP029	7/1		
			89.96	+0.02	8566DC			900XSY	CW20	WP029	7/1		
			95.44	+5.5	8566D550			955XSY	CW20	WP029	7/1		
KFX450 12.0:1	08-10	449	95.96	Std.	8773DA	2.14	26.10	960ADS-2	CW21	WP051	7	D4077	P4019
			95.97	+0.01	8773DB			960ADS-2	CW21	WP051	7		
			95.98	+0.02	8773DC			960ADS-2	CW21	WP051	7		
			97.96	+2.0	8773D200			980ADS-2	CW21	WP051	7		
			99.96	+4.0	8773D400			1000ADS	CW21	WP051	7		
KFX450 13.5:1 Pro Series 2 Ring	08-09	449	95.96	Std.	8709DA	-	26.10	960ADS-2	CW21	WP051	7	D4017	P4019
			95.97	+0.01	8709DB			960ADS-2	CW21	WP051	7		
			95.98	+0.02	8709DC			960ADS-2	CW21	WP051	7		
KFX700 11.3:1 HC	04-09	697	81.93	Std.	8679DA	-	26.30	820XSY	CW20	WP038	7/1	-	-
			82.43	+0.5	8679D050			825XSY	CW20	WP038	7/1		
			82.93	+1.0	8679D100			830XSY	CW20	WP038	7/1		
			83.43	+1.5	8679D150			835XSY-3	CW20	WP038	7/1		
			83.93	+2.0	8679D200			840XSY	CW20	WP038	7/1		



## KTM 2-stroke



					set includes							extra parts	
													
Model	Years	Displ. (cc)	Piston Size (mm)	Over-sizes (mm)	Piston Kit Part No.	Dome Volume (cm <sup>3</sup> )	Comp. Height (mm)	Ring Set Part No.	Clip Part No.	Pin Part No.	Price-code	Top End Gasket Kit	Wössner Connecting Rods
SX50	01-08	60	43.46	Std.	8225DA	-	-	RSB4350	0	0	1	-	-
			43.47	+0.01	8225DB			RSB4350	0	0	1		
			43.48	+0.02	8225DC			RSB4350	0	0	1		
SX60	97-08	60	43.45	Std.	8240DA	-	21.60	RSB4350	CW12	WP091	1		
			43.46	+0.01	8240DB			RSB4350	CW12	WP091	1		
			43.47	+0.02	8240DC			RSB4350	CW12	WP091	1		
SX65	97-08	63	44.96	Std.	8198DA	-	21.70	RSB4500	CW12	WP091	1	D2019 / D2020	P2002
			44.97	+0.01	8198DB			RSB4500	CW12	WP091	1		
			44.98	+0.02	8198DC			RSB4500	CW12	WP091	1		
			44.99	+0.03	8198DD			RSB4500	CW12	WP091	1		
			45.00	+0.04	8198DE			RSB4500	CW12	WP091	1		
SX65	09	63	44.96	Std.	8241DA	-	21.60	RSB4500	CW12	WP091	1	D2016	-
			44.97	+0.01	8241DB			RSB4500	CW12	WP091	1		
			44.98	+0.02	8241DC			RSB4500	CW12	WP091	1		
			44.99	+0.03	8241DD			RSB4500	CW12	WP091	1		
			45.00	+0.04	8241DE			RSB4500	CW12	WP091	1		
SX85	03-09	84	46.95	Std.	8147DA	-	24	RSB4700	CW14	WP058	1	D2017	P2006
			46.96	+0.01	8147DB			RSB4700	CW14	WP058	1		
			46.97	+0.02	8147DC			RSB4700	CW14	WP058	1		
SX105 Single Ring will not fit 85cc over bore	03-08	104	51.94	Std.	8224DA	-	24	RSB5200	CW14	WP058	2/1	-	P2006
			51.95	+0.01	8224DB			RSB5200	CW14	WP058	2/1		
			51.96	+0.02	8224DC			RSB5200	CW14	WP058	2/1		
SX125	84-86	125	53.94	Std.	8030DA	-	30	RSB5400	CW15	WP032	2/1	-	-
			53.95	+0.01	8030DB			RSB5400	CW15	WP032	2/1		
			53.96	+0.02	8030DC			RSB5400	CW15	WP032	2/1		
			54.44	+0.5	8030D050			RSB5450	CW15	WP032	2/1		
GS & MX125	87-93	125	54.19	Std.	8011DA	-	28	RDB5425	CW15	WP032	2	-	-
			54.20	+0.01	8011DB			RDB5425	CW15	WP032	2		
			54.21	+0.02	8011DC			RDB5425	CW15	WP032	2		
			54.22	+0.03	8011DD			RDB5425	CW15	WP032	2		
			54.69	+0.5	8011D050			RDB5475	CW15	WP032	2		

## KTM 2-stroke





					set includes							extra parts	
													
Model	Years	Displ. (cc)	Piston Size (mm)	Over-sizes (mm)	Piston Kit Part No.	Dome Volume (cm <sup>3</sup> )	Comp. Height (mm)	Ring Set Part No.	Clip Part No.	Pin Part No.	Price-code	Top End Gasket Kit	Wössner Connecting Rods
EGS & GS & SX & EXC125	94-00	125	54.19	Std.	8029DA	-	27.85	RSB5425	CW15	WP032	2	D2018	P2011
			54.20	+0.01	8029DB			RSB5425	CW15	WP032	2		
			54.21	+0.02	8029DC			RSB5425	CW15	WP032	2		
			54.69	+0.5	8029D050			RSB5475	CW15	WP032	2		
			56.19	+2.0	8029D200			RSB5625	CW15	WP032	2		
EXC125	01-09	125	53.95	Std.	8174DA	-	29.50	RDB5400	CW15	WP032	2	D2018 / D2021	P2011 / P2012
			53.96	+0.01	8174DB			RDB5400	CW15	WP032	2		
			53.97	+0.02	8174DC			RDB5400	CW15	WP032	2		
			53.98	+0.03	8174DD			RDB5400	CW15	WP032	2		
			54.45	+0.5	8174D050			RDB5450	CW15	WP032	2		
			54.95	1.0	8174D100			RDB5500	CW15	WP032	2		
SX125 Single Ring	01-06	125	53.95	Std.	8056DA	-	29.50	RSB5400	CW15	WP032	2	D2043	P2011
			53.96	+0.01	8056DB			RSB5400	CW15	WP032	2		
			53.97	+0.02	8056DC			RSB5400	CW15	WP032	2		
			55.95	+2.0	8056D200			RSB5600	CW15	WP032	2		
SX125 Single Ring	07-09	125	53.95	Std.	8220DA	-	29.50	RSB5400	CW15	WP032	2	D2043	P2012
			53.96	+0.01	8220DB			RSB5400	CW15	WP032	2		
			53.97	+0.02	8220DC			RSB5400	CW15	WP032	2		
			55.95	+2.0	8220D200			RSB5600	CW15	WP032	2		
			57.95	+4.0	8220D400			RSB5800	CW15	WP032	2		
SX144 Single Ring	07-08	144	55.95	Std.	8222DA	-	29.50	RSB5600	CW15	WP032	2	-	P2012
			55.96	+0.01	8222DB			RSB5600	CW15	WP032	2		
			55.97	+0.02	8222DC			RSB5600	CW15	WP032	2		
SX150 Single Ring	09-10	144	55.95	Std.	8222DA	-	29.50	RSB5600	CW15	WP032	2	-	P2012
			55.96	+0.01	8222DB			RSB5600	CW15	WP032	2		
			55.97	+0.02	8222DC			RSB5600	CW15	WP032	2		



## KTM 2-stroke

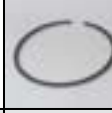

					set includes							extra parts	
													
Model	Years	Displ. (cc)	Piston Size (mm)	Over-sizes (mm)	Piston Kit Part No.	Dome Volume (cm <sup>3</sup> )	Comp. Height (mm)	Ring Set Part No.	Clip Part No.	Pin Part No.	Price-code	Top End Gasket Kit	Wössner Connecting Rods
LC2	all	125	55.94	Std.	8143DA	-	29.90	RDB5600	CW16	WP036	2/1	-	-
			56.19	+0.25	8143D025			RDB5625	CW16	WP036	2/1		
			56.44	+0.5	8143D050			RDB5650	CW16	WP036	2/1		
			56.69	+0.75	8143D075			RDB5675	CW16	WP036	2/1		
			56.94	+1.0	8143D100			RDB5700	CW16	WP036	2/1		
			57.19	+1.25	8143D125			RDB5725	CW16	WP036	2/1		
			57.44	+1.5	8143D150			RDB5750	CW16	WP036	2/1		
			57.94	+2.0	8143D200			RDB5800	CW16	WP036	2/1		
			58.44	+2.5	8143D250			RDB5850	CW16	WP036	2/1		
			58.94	+3.0	8143D300			RDB5900	CW16	WP036	2/1		
			59.94	+4.0	8143D400			RDB6000	CW16	WP036	2/1		
60.44	+4.5	8143D450	RDB6050	CW16	WP036	2/1							
60.94	+5.0	8143D500	RDB6100	CW16	WP036	2/1							
EGS & EXC & SX200	98-09	200	63.94	Std.	8048DA	-	28	RDB6400	CW16	WP027	3	D2022	-
			63.95	+0.01	8048DB			RDB6400	CW16	WP027	3		
			63.96	+0.02	8048DC			RDB6400	CW16	WP027	3		
EXC250	77-82	249	72.43	+1.5	8034D150	-	38	RSB7250	CW18	WP033	3/1	-	-
			72.93	+2.0	8034D200			RSB7300	CW18	WP033	3/1		
MX & MXC & GS240 & GS250	84	249	71.93	+1.0	8050D100	-	30	RDB7200	CW18	WP033	3/1	-	-
			72.43	+1.5	8050D150			RDB7250	CW18	WP033	3/1		
			72.93	+2.0	8050D200			RDB7300	CW18	WP033	3/1		
GS240 & GS250	85-88	-	66.44	Std.	8025DA	-	29.70	RSB6650	CW18	WP033	3	-	-
			66.94	+0.5	8025D050			RSB6700	CW18	WP033	3		
			67.44	+1.0	8025D100			RSB6750	CW18	WP033	3		
			67.94	+1.5	8025D150			RSB6800	CW18	WP033	3		
MX & SX250	90-94	249	67.44	Std.	8005DA	-	29.70	RDB6750	CW18	WP033	3	-	-
			67.45	+0.01	8005DB			RDB6750	CW18	WP033	3		
			67.46	+0.02	8005DC			RDB6750	CW18	WP033	3		
			67.94	+0.5	8005D050			RDB6800	CW18	WP033	3		
			68.44	+1.0	8005D100			RDB6850	CW18	WP033	3		

## KTM 2-stroke



Model	Years	Displ. (cc)	Piston Size (mm)	Over-sizes (mm)	Piston Kit Part No.	Dome Volume (cm <sup>3</sup> )	Comp. Height (mm)	set includes					extra parts	
								Ring Set Part No.	Clip Part No.	Pin Part No.	Price-code	Top End Gasket Kit	Wössner Connecting Rods	
GS & SX250	95	249	67.44	Std.	8014DA	-	29.70	RDB6750	CW18	WP033	3/1	-	-	
			67.45	+0.01	8014DB			RDB6750	CW18	WP033	3/1			
			67.46	+0.02	8014DC			RDB6750	CW18	WP033	3/1			
			67.94	+0.5	8014D050			RDB6800	CW18	WP033	3/1			
			68.44	+1.0	8014D100			RDB6850	CW18	WP033	3/1			
EGS & EXC & SX250	96-99	249	67.44	Std.	8016DA	-	26.70	RDB6750	CW18	WP033	3	D2023	P2024	
			67.45	+0.01	8016DB			RDB6750	CW18	WP033	3			
			67.46	+0.02	8016DC			RDB6750	CW18	WP033	3			
			67.94	+0.5	8016D050			RDB6800	CW18	WP033	3			
			68.44	+1.0	8016D100			RDB6850	CW18	WP033	3			
EXC250	00-05	249	66.34	Std.	8081DA	-	38	RDB6640	CW18	WP033	3	D2023	P2023	
			66.35	+0.01	8081DB			RDB6640	CW18	WP033	3			
			66.36	+0.02	8081DC			RDB6640	CW18	WP033	3			
SX250	00-02	249	66.34	Std.	8090DA	-	38	RSB6640	CW18	WP033	3/1	D2023	-	
			66.35	+0.01	8090DB			RSB6640	CW18	WP033	3/1			
			66.36	+0.02	8090DC			RSB6640	CW18	WP033	3/1			
			66.94	+0.6	8090D060			RSB6700	CW18	WP033	3/1			
SX250	03-04	249	66.34	Std.	8082DA	-	38	RSB6640	CW18	WP033	3	D2023 / D2024	P2023	
			66.35	+0.01	8082DB			RSB6640	CW18	WP033	3			
			66.36	+0.02	8082DC			RSB6640	CW18	WP033	3			
SX250 & EXC250	05-09	249	66.34	Std.	8169DA	-	38	RDB6640	CW18	WP033	3	D2024 / D2025	P2023	
			66.35	+0.01	8169DB			RDB6640	CW18	WP033	3			
			66.36	+0.02	8169DC			RDB6640	CW18	WP033	3			
GS & MX300	91-94	297	71.93	Std.	8012DA	-	29.70	RDB7200	CW18	WP039	6	-	-	
			71.94	+0.01	8012DB			RDB7200	CW18	WP039	6			
			71.95	+0.02	8012DC			RDB7200	CW18	WP039	6			
			72.43	+0.5	8012D050			RDB7250	CW18	WP039	6			
			72.93	+1.0	8012D100			RDB7300	CW18	WP039	6			

## KTM 2-stroke



					set includes							extra parts	
Model	Years	Displ. (cc)	Piston Size (mm)	Over-sizes (mm)	Piston Kit Part No.	Dome Volume (cm <sup>3</sup> )	Comp. Height (mm)	Ring Set Part No.	Clip Part No.	Pin Part No.	Price-code	Top End Gasket Kit	Wössner Connecting Rods
GS & SX300	95	297	71.93	Std.	8042DA	-	29.70	RDB7200	CW18	WP033	6	-	-
			71.94	+0.01	8042DB			RDB7200	CW18	WP033	6		
			71.95	+0.02	8042DC			RDB7300	CW18	WP033	6		
EGS & EXC300	96-03	297	71.93	Std.	8017DA	-	26.70	RDB7200	CW18	WP033	6	D2023	P2024
			71.94	+0.01	8017DB			RDB7200	CW18	WP033	6		
			71.95	+0.02	8017DC			RDB7200	CW18	WP033	6		
			72.43	+0.5	8017D050			RDB7250	CW18	WP033	6		
			72.93	+1.0	8017D100			RDB7300	CW18	WP033	6		
EXC & MXC300	04-07	297	71.94	Std.	8219DA	-	38	RDB7200	CW18	WP033	6	D2024	P2023
			71.95	+0.01	8219DB			RDB7200	CW18	WP033	6		
			71.96	+0.02	8219DC			RDB7200	CW18	WP033	6		
EXC & MXC300	08-09	297	71.94	Std.	8250DA	-	-	RDB7200	CW18	WP033	6	-	P2023
			71.95	+0.01	8250DB			RDB7200	CW18	WP033	6		
			71.96	+0.02	8250DC			RDB7200	CW18	WP033	6		
EGS & EXC & SX360	96-01	353	77.94	Std.	8083DA	-	27	RSC7800	CW18	WP039	6	-	-
			77.95	+0.01	8083DB			RSC7800	CW18	WP039	6		
			77.96	+0.02	8083DC			RSC7800	CW18	WP039	6		
			78.44	+0.5	8083D050			RSC7850	CW18	WP039	6		
			78.94	+1.0	8083D100			RSC7900	CW18	WP039	6		
EGS & EXC & SX380	98-03	368	77.94	Std.	8223DA	-	27	RSC7800	CW18	WP039	6	-	-
			77.95	+0.01	8223DB			RSC7800	CW18	WP039	6		
			77.96	+0.02	8223DC			RSC7800	CW18	WP039	6		
			78.44	+0.5	8223D050			RSC7850	CW18	WP039	6		
			78.94	+1.0	8223D100			RSC7900	CW18	WP039	6		

## KTM 4-stroke



Model	Years	Displ. (cc)	Piston Size (mm)	Over-sizes (mm)	Piston Kit Part No.	Dome Volume (cm <sup>3</sup> )	Comp. Height (mm)	set includes				extra parts	
								Ring Set Part No.	Clip Part No.	Pin Part No.	Price-code	Top End Gasket Kit	Wössner Connecting Rods
EXC250 Racing	01-05	249	74.95	Std.	8592DA	-	25.30	750XDS	CW20	WP029	5/1	-	-
			74.96	+0.01	8592DB			750XDS	CW20	WP029	5/1		
			74.97	+0.02	8592DC			750XDS	CW20	WP029	5/1		
EXC250 Racing	06-09	249	75.96	Std.	8645DA	-1.2	19.50	760XAS-2	CW16	WP070	5	-	-
			75.97	+0.01	8645DB			760XAS-2	CW16	WP070	5		
			75.98	+0.02	8645DC			760XAS-2	CW16	WP070	5		
SX-F 250	06-09	249	75.96	Std.	8645DA	-1.2 (D400 = -3.7)	19.50	760XAS-2	CW16	WP070 (D400 = WP059)	5	D4018	P4003
			75.97	+0.01	8645DB			760XAS-2	CW16		5		
			75.98	+0.02	8645DC			760XAS-2	CW16		5		
			79.96	+4.0	8645D400			800XDS-3	CW16		5		
SX-F 250 Pro Series 14.4:1	06-09	249	75.96	Std.	8690DA	-	19.50	760XAS-2	CW16	WP059	5/1	D4018	P4003
			75.97	+0.01	8690DB			760XAS-2	CW16	WP059	5/1		
			75.98	+0.02	8690DC			760XAS-2	CW16	WP059	5/1		
			79.96	+4.0	8690D400			800XDS-3	CW16	WP059	5/1		
350LC4	92-94	349	88.94	Std.	8506DA	-	26.50	890XSY-3	CW22	WP017	7/1	-	-
			88.95	+0.01	8506DB			890XSY-3	CW22	WP017	7/1		
			88.96	+0.02	8506DC			890XSY-3	CW22	WP017	7/1		
400LC4	93-96	400	94.94	Std.	8520DA	-	26.50	950XSY-3	CW22	WP009	7/1	-	-
			94.95	+0.01	8520DB			950XSY-3	CW22	WP009	7/1		
			94.96	+0.02	8520DC			950XSY-3	CW22	WP009	7/1		
400LC4	97	398	88.94	Std.	8506DA	-	26.50	890XSY-3	CW22	WP017	7/1	-	-
			88.95	+0.01	8506DB			890XSY-3	CW22	WP017	7/1		
			88.96	+0.02	8506DC			890XSY-3	CW22	WP017	7/1		
EXC & SX400	00-04	398	88.94	Std.	8580DA	-	27.50	890XSY	CW20	WP038	7/1	-	-
			88.95	+0.01	8580DB			890XSY	CW20	WP038	7/1		
			88.96	+0.02	8580DC			890XSY	CW20	WP038	7/1		
			90.94	+2.0	8580D200			910XSY-3	CW20	WP038	7/1		
EXC & SX400 Pro Series 12.5:1	00-04	398	88.94	Std.	8636DA	-	27.50	890XSY	CW20	WP038	7	-	-
			88.95	+0.01	8636DB			890XSY	CW20	WP038	7		
			88.96	+0.02	8636DC			890XSY	CW20	WP038	7		
			90.94	+2.0	8636D200			910XSY-3	CW20	WP038	7		





## KTM 4-stroke



Model	Years	Displ. (cc)	Piston Size (mm)	Over-sizes (mm)	Piston Kit Part No.	Dome Volume (cm <sup>3</sup> )	Comp. Height (mm)	set includes				extra parts	
								Ring Set Part No.	Clip Part No.	Pin Part No.	Price-code	Top End Gasket Kit	Wössner Connecting Rods
EXC450	02-07	449	88.96	Std.	8581DA	-	23.50	890XS	CW20	WP038	7	-	P4015
			88.97	+0.01	8581DB			890XS	CW20	WP038	7		
			88.98	+0.02	8581DC			890XS	CW20	WP038	7		
EXC450R	08-09	449	94.95	Std.	8707DA	-1.9	22.80	950ADS-2	CW19	WP037	7	-	P4016
			94.96	+0.01	8707DB			950ADS-2	CW19	WP037	7		
			94.97	+0.02	8707DC			950ADS-2	CW19	WP037	7		
SX-F450	02-06	449	94.96	Std.	8560DA	+5.8	21.60	950ADS-2	CW20	WP038	7	D4020	P4015 / P4018
			94.97	+0.01	8560DB			950ADS-2	CW20	WP038	7		
			94.98	+0.02	8560DC			950ADS-2	CW20	WP038	7		
			96.96	+2.0	8560D200			970ADS-2	CW20	WP038	7		
SX-F450 Pro Series	02-06	449	94.96	Std.	8571DA	-	21.60	950ADS-2	CW20	WP038	7/1	D4020	P4015 / P4018
			94.97	+0.01	8571DB			950ADS-2	CW20	WP038	7/1		
			94.98	+0.02	8571DC			950ADS-2	CW20	WP038	7/1		
			96.96	+2.0	8571D200			970ADS-2	CW20	WP038	7/1		
SX-F450 12.5:1	07-09	449	96.96	Std.	8665DA	-2.6	21.30	970ADS-2	CW19	WP037	7	D4019	P4017
			96.97	+0.01	8665DB			970ADS-2	CW19	WP037	7		
			96.98	+0.02	8665DC			970ADS-2	CW19	WP037	7		
SX-F450 Pro Series 13.5:1	07-09	449	96.96	Std.	8715DA	+1.1	21.30	970ADS-2	CW19	WP037	7/1	D4019	P4017
			96.97	+0.01	8715DB			970ADS-2	CW19	WP037	7/1		
			96.98	+0.02	8715DC			970ADS-2	CW19	WP037	7/1		
SX-F505 12.5:1	08-09	477	99.95	Std.	8705DA	-3	21.40	1000ADS-2	CW20	WP038	7/1	-	-
			99.96	+0.01	8705DB			1000ADS-2	CW20	WP038	7/1		
			99.97	+0.02	8705DC			1000ADS-2	CW20	WP038	7/1		
SX-F505 Pro Series 13.5:1	08-09	477	99.95	Std.	8725DA	+0.3	21.80	1000ADS-2	CW20	WP038	7/1	-	-
			99.96	+0.01	8725DB			1000ADS-2	CW20	WP038	7/1		
			99.97	+0.02	8725DC			1000ADS-2	CW20	WP038	7/1		
EXC & SX520-525	00-09	510	94.95	Std.	8547DA	-	23.50	950ADS-2	CW20	WP038	7/1	-	-
			94.96	+0.01	8547DB			950ADS-2	CW20	WP038	7/1		
			94.97	+0.02	8547DC			950ADS-2	CW20	WP038	7/1		
			95.95	+1.0	8547D100			960ADS-2	CW20	WP038	7/1		
			96.95	+2.0	8547D200			970ADS-2	CW20	WP038	7/1		





## KTM 4-stroke



					set includes							extra parts	
													
Model	Years	Displ. (cc)	Piston Size (mm)	Over-sizes (mm)	Piston Kit Part No.	Dome Volume (cm <sup>3</sup> )	Comp. Height (mm)	Ring Set Part No.	Clip Part No.	Pin Part No.	Price-code	Top End Gasket Kit	Wössner Connecting Rods
EXC & SX520-525 Pro Series 12.5:1	00-09	510	94.95	Std.	8637DA	+4.61	23.50	950ADS-2	CW20	WP038	7/1	-	-
			94.96	+0.01	8637DB			950ADS-2	CW20	WP038	7/1		
			94.97	+0.02	8637DC			950ADS-2	CW20	WP038	7/1		
			96.95	+2.0	8637D200			970ADS-2	CW20	WP038	7/1		
EXC & SX520-525	00-09	565	99.95	Std.	8583DA	-	24.50	1000ADS-2	CW20	WP038	7	D4021	P4015
			99.96	+0.01	8583DB			1000ADS-2	CW20	WP038	7		
			99.97	+0.02	8583DC			1000ADS-2	CW20	WP038	7		
EXC530R Pro Series 12.5:1	08-09	510	94.96	Std.	8706DA	-2.8	24.40	950ADS-2	CW19	WP037	7	-	-
			94.97	+0.01	8706DB			950ADS-2	CW19	WP037	7		
			94.98	+0.02	8706DC			950ADS-2	CW19	WP037	7		
EXC560	all	560	93.94	Std.	8508DA	-	29.50	940XSY-3	CW22	WP017	7	-	-
			94.94	+1.0	8508D100			950XSY-3	CW22	WP017	7		
SMR560 Pro Series 12.0:1	06-09	600	99.95	Std.	8704DA	+5.16	23.40	1000ADS-2	CW20	WP038	7/1	-	-
			99.96	+0.01	8704DB			1000ADS-2	CW20	WP038	7/1		
			99.97	+0.02	8704DC			1000ADS-2	CW20	WP038	7/1		
600LC4	88-92	600	94.94	Std.	08520DA	-	26.50	950XSY-3	CW22	WP009	7/1	-	-
			94.95	+0.01	08520DB			950XSY-3	CW22	WP009	7/1		
			94.96	+0.02	08520DC			950XSY-3	CW22	WP009	7/1		
600LC4	93	600	99.94	Std.	8521DA	-	26.50	1000XSY-3	CW22	WP009	7/1	-	-
			99.95	+0.01	8521DB			1000XSY-3	CW22	WP009	7/1		
			99.96	+0.02	8521DC			1000XSY-3	CW22	WP009	7/1		
620 & 625 & 640LC4 & SX & Duke & Supermoto	94-09	620	100.94	Std.	8524DA	-	26.50	1010XSY-3	CW22	WP009	7/1	-	-
			100.95	+0.01	8524DB			1010XSY-3	CW22	WP009	7/1		
			100.96	+0.02	8524DC			1010XSY-3	CW22	WP009	7/1		
			101.94	+1.0	8524D100			1020XSU-3	CW22	WP009	7/1		
660 SMC	03-09	660	101.94	+1.0	8524D100	-	26.50	1020XSU-3	CW22	WP009	7/1	-	-





## MAICO 2-stroke



					set includes							extra parts	
													
Model	Years	Displ. (cc)	Piston Size (mm)	Over-sizes (mm)	Piston Kit Part No.	Dome Volume (cm <sup>3</sup> )	Comp. Height (mm)	Ring Set Part No.	Clip Part No.	Pin Part No.	Price-code	Top End Gasket Kit	Wössner Connecting Rods
250	73-81	247	66.93	Std.	8031DA	-	41.70	RSB6700	CW18	WP033	3/1	-	-
			67.18	+0.25	8031D025			RSB6725	CW18	WP033	3/1		
			67.43	+0.5	8031D050			RSB6750	CW18	WP033	3/1		
			67.93	+1.0	8031D100			RSB6800	CW18	WP033	3/1		
			68.43	+1.5	8031D150			RSB6850	CW18	WP033	3/1		
			68.93	+2.0	8031D200			RSB6900	CW18	WP033	3/1		
250	86-02	247	66.93	Std.	8045DA	-	35.70	RSB6700	CW18	WP033	3/1	-	-
			67.43	+0.5	8045D050			RSB6750	CW18	WP033	3/1		
			67.93	+1.0	8045D100			RSB6800	CW18	WP033	3/1		
			68.43	+1.5	8045D150			RSB6850	CW18	WP033	3/1		
			68.93	+2.0	8045D200			RSB6900	CW18	WP033	3/1		
400	73-81	400	76.92	Std.	8047DA	-	41.70	RSC7700	CW18	WP039	6	-	-
			77.42	+0.5	8047D050			RSC7750	CW18	WP039	6		
			77.92	+1.0	8047D100			RSC7800	CW18	WP039	6		
			78.42	+1.5	8047D150			RSC7850	CW18	WP039	6		
			78.92	+2.0	8047D200			RSC7900	CW18	WP039	6		
440	73-81	440	81.92	Std.	8099DA	-	41.70	RSC8200	CW18	WP039	6	-	-
			82.42	+0.5	8099D050			RSC8250	CW18	WP039	6		
			82.92	+1.0	8099D100			RSC8300	CW18	WP039	6		
			83.42	+1.5	8099D150			RSC8350	CW18	WP039	6		
			83.92	+2.0	8099D200			RSC8400	CW18	WP039	6		
490 & 500	81-02	498	86.42	Std.	8036DA	-	41.70	RSC8650	CW18	WP042	6/1	-	-
			86.92	+0.5	8036D050			RSC8700	CW18	WP042	6/1		
			87.42	+1.0	8036D100			RSC8750	CW18	WP042	6/1		

## POLARIS 2-stroke



					set includes							extra parts	
													
Model	Years	Displ. (cc)	Piston Size (mm)	Over-sizes (mm)	Piston Kit Part No.	Dome Volume (cm <sup>3</sup> )	Comp. Height (mm)	Ring Set Part No.	Clip Part No.	Pin Part No.	Price-code	Top End Gasket Kit	Wössner Connecting Rods
Trail Boss & Scrambler & Trail Blazer250	all	-	71.93	Std.	8094DA	-	38	RDB7200	CW18	WP033	3/1	-	-
		71.94	+0.01	8094DB	RDB7200			CW18	WP033	3/1			
		71.95	+0.02	8094DC	RDB7200			CW18	WP033	3/1			
		72.43	+0.5	8094D050	RDB7250			CW18	WP033	3/1			
		72.93	+1.0	8094D100	RDB7300			CW18	WP033	3/1			
		73.43	+1.5	8094D150	RDB7350			CW18	WP033	3/1			
		73.93	+2.0	8094D200	RDB7400			CW18	WP033	3/1			
ATV300	94-00	-	74.43	Std.	8095DA	-	33	RDC7450	CW18	WP033	6	-	-
		74.44	+0.01	8095DB	RDC7450			CW18	WP033	6			
		74.45	+0.02	8095DC	RDC7450			CW18	WP033	6			
		74.93	+0.5	8095D050	RDC7500			CW18	WP033	6			
		75.43	+1.0	8095D100	RDC7550			CW18	WP033	6			
		75.93	+1.5	8095D150	RDC7600			CW18	WP033	6			
		76.43	+2.0	8095D200	RDC7650			CW18	WP033	6			
Trail Boss350	all	-	79.93	Std.	8096DA	-	38	RDC8000	CW18	WP039	6	-	-
		79.94	+0.01	8096DB	RDC8000			CW18	WP039	6			
		79.95	+0.02	8096DC	RDC8000			CW18	WP039	6			
		80.43	+0.5	8096D050	RDC8050			CW18	WP039	6			
		80.93	+1.0	8096D100	RDC8100			CW18	WP039	6			
		81.43	+1.5	8096D150	RDC8150			CW18	WP039	6			
		81.93	+2.0	8096D200	RDC8200			CW18	WP039	6			
ATV400	thru 03	-	82.93	Std.	8097DA	-	38	RDC8300	CW18	WP039	6	-	-
		82.94	+0.01	8097DB	RDC8300			CW18	WP039	6			
		82.95	+0.02	8097DC	RDC8300			CW18	WP039	6			
		83.43	+0.5	8097D050	RDC8350			CW18	WP039	6			
		83.93	+1.0	8097D100	RDC8400			CW18	WP039	6			
		84.43	+1.5	8097D150	RDC8450			CW18	WP039	6			



## POLARIS 4-stroke



Model	Years	Displ. (cc)	Piston Size (mm)	Over-sizes (mm)	Piston Kit Part No.	Dome Volume (cm <sup>3</sup> )	Comp. Height (mm)	set includes				extra parts	
								Ring Set Part No.	Clip Part No.	Pin Part No.	Price-code	Top End Gasket Kit	Wössner Connecting Rods
500 Xplorer & ATP 500 H.O & Sportsman & Scrambler	96-05	-	91.95	Std.	8691DA	-9.2	33.30	920XSY	CW23	WP024	7/1	-	-
			92.45	+0.5	8691D050			925XSY	CW23	WP024	7/1		
			92.95	+1.0	8691D100			930XSY	CW23	WP024	7/1		
Predator-HC	03-09	-	99.14	Std.	8692DA	+5.2	28.80	992XSY	CW23	WP008	7/1	-	-
Outlaw 500-HC 12.5:1	06-09	-	99.14	Std.	8692DA	+5.2	28.80	992XSY	CW23	WP008	7/1	-	-
Outlaw 525	07-09	-	94.95	Std.	8693DA	-2.1	23.50	950ADS	CW20	WP038	7/1	-	-
			96.95	+2.0	8693D200			970ADS	CW20	WP038	7/1		
Outlaw 525 High Comp. 12.5:1	07-09	510	94.94	Std.	8694DA	+4.61	23.50	950ADS-2	CW20	WP038	7/1	-	-
			96.94	+2.0	8694D200			970ADS-2	CW20	WP038	7/1		

Sven Breugelsman  
JM Racing KTM  
World Champion MX3 2008



## SUZUKI 2-stroke



					set includes							extra parts		
														
Model	Years	Displ. (cc)	Piston Size (mm)	Over-sizes (mm)	Piston Kit Part No.	Dome Volume (cm <sup>3</sup> )	Comp. Height (mm)	Ring Set Part No.	Clip Part No.	Pin Part No.	Price-code	Top End Gasket Kit	Wössner Connecting Rods	
RM65	03-09	65	44.45	Std.	8196DA	-	23.60	RSB4500	CW12	WP091	1	-	P2001	
			44.46	+0.01	8196DB			RSB4500	CW12	WP091	1			
			44.47	+0.02	8196DC			RSB4500	CW12	WP091	1			
			44.48	+0.03	8196DD			RSB4500	CW12	WP091	1			
RM80	77-81	-	48.95	Std.	8226DA	-	27.50	RSB4900	CW12	WP091	1/1	-	-	
			49.45	+0.5	8226D050			RSB4950	CW12	WP091	1/1			
			49.95	+1.0	8226D100			RSB5000	CW12	WP091	1/1			
			50.45	+1.5	8226D150			RSB5050	CW12	WP091	1/1			
			50.95	+2.0	8226D200			RSB5100	CW12	WP091	1/1			
RM80	86-87	-	47.45	Std.	8227DA	-	-	RSB4750	CW14	WP058	1/1	-	-	
			47.95	+0.5	8227D050			RSB4800	CW14	WP058	1/1			
			48.45	+1.0	8227D100			RSB4850	CW14	WP058	1/1			
			48.95	+1.5	8227D150			RSB4900	CW14	WP058	1/1			
			49.45	+2.0	8227D200			RSB4950	CW14	WP058	1/1			
RM80	89-90	82	47.45	Std.	8191DA	-	27	RSB4750	CW14	WP058	1/1	-	-	
			47.95	+0.5	8191D050			RSB4800	CW14	WP058	1/1			
			48.45	+1.0	8191D100			RSB4850	CW14	WP058	1/1			
			48.95	+1.5	8191D150			RSB4900	CW14	WP058	1/1			
			49.45	+2.0	8191D200			RSB4950	CW14	WP058	1/1			
RM80 International Bore	91-01	82	46.45	Std.	8231DA	-	27	RSB4650	CW14	WP058	1/1	-	-	
			46.46	+0.01	8231DB			RSB4650	CW14	WP058	1/1			
			46.47	+0.02	8231DC			RSB4650	CW14	WP058	1/1			
RM85	02-09	84	47.95	Std.	8103DA	-	27	RSB4800	CW14	WP058	1	D2026	P2007	
			47.96	+0.01	8103DB			RSB4800	CW14	WP058	1			
			47.97	+0.02	8103DC			RSB4800	CW14	WP058	1			
RM100	03	-	52.45	Std.	8254DA	-	26	RSB5250	CW14	WP025	1	-	P2005	
			52.95	+0.5	8254D050			RSB5300	CW14	WP025	1			
			53.45	+1.0	8254D100			RSB5350	CW14	WP025	1			
			53.95	+1.5	8254D150			RSB5400	CW14	WP025	1			
			54.45	+2.0	8254D200			RSB5450	CW14	WP025	1			





## SUZUKI 2-stroke



					set includes							extra parts	
Model	Years	Displ. (cc)	Piston Size (mm)	Over-sizes (mm)	Piston Kit Part No.	Dome Volume (cm <sup>3</sup> )	Comp. Height (mm)	Ring Set Part No.	Clip Part No.	Pin Part No.	Price-code	Top End Gasket Kit	Wössner Connecting Rods
RM125	77-80	123	53.94	Std.	8192DA	-	30.50	RDB5400	CW14	WP025	2/1	-	-
			54.44	+0.5	8192D050			RDB5450	CW14	WP025	2/1		
			54.94	+1.0	8192D100			RDB5500	CW14	WP025	2/1		
			55.44	+1.5	8192D150			RDB5550	CW14	WP025	2/1		
			55.94	+2.0	8192D200			RDB5600	CW14	WP025	2/1		
RM125	81-84	123	53.94	Std.	8124DA	-	29.50	RDB5400	CW14	WP025	2/1	-	P2040
			54.19	+0.25	8124D025			RDB5425	CW14	WP025	2/1		
			54.44	+0.5	8124D050			RDB5450	CW14	WP025	2/1		
			54.69	+0.75	8124D075			RDB5475	CW14	WP025	2/1		
			54.94	+1.0	8124D100			RDB5500	CW14	WP025	2/1		
			55.19	+1.25	8124D125			RDB5525	CW14	WP025	2/1		
			55.44	+1.5	8124D150			RDB5550	CW14	WP025	2/1		
55.94	+2.0	8124D200	RDB5600	CW14	WP025	2/1							
RM125	85-86	123	53.94	Std.	8123DA	-	29.50	RDB5400	CW14	WP025	2/1	-	P2040
			54.19	+0.25	8123D025			RDB5425	CW14	WP025	2/1		
			54.44	+0.5	8123D050			RDB5450	CW14	WP025	2/1		
			54.69	+0.75	8123D075			RDB5475	CW14	WP025	2/1		
			54.94	+1.0	8123D100			RDB5500	CW14	WP025	2/1		
			55.19	+1.25	8123D125			RDB5525	CW14	WP025	2/1		
			55.44	+1.5	8123D150			RDB5550	CW14	WP025	2/1		
55.94	+2.0	8123D200	RDB5600	CW14	WP025	2/1							
RM125	87	123	53.94	Std.	8122DA	-	29.50	RSB5400	CW14	WP025	2/1	-	-
			53.95	+0.01	8122DB			RSB5400	CW14	WP025	2/1		
			54.44	+0.5	8122D050			RSB5450	CW14	WP025	2/1		
			54.94	+1.0	8122D100			RSB5500	CW14	WP025	2/1		
			55.44	+1.5	8122D150			RSB5550	CW14	WP025	2/1		
55.94	+2.0	8122D200	RSB5600	CW14	WP025	2/1							

## SUZUKI 2-stroke



					set includes							extra parts	
													
Model	Years	Displ. (cc)	Piston Size (mm)	Over-sizes (mm)	Piston Kit Part No.	Dome Volume (cm <sup>3</sup> )	Comp. Height (mm)	Ring Set Part No.	Clip Part No.	Pin Part No.	Price-code	Top End Gasket Kit	Wössner Connecting Rods
RM125	88	123	53.94	Std.	8138DA	-	29.50	RSB5400	CW15	WP032	2/1	-	P2015
			53.95	+0.01	8138DB			RSB5400	CW15	WP032	2/1		
			54.44	+0.5	8138D050			RSB5450	CW15	WP032	2/1		
			54.94	+1.0	8138D100			RSB5500	CW15	WP032	2/1		
			55.44	+1.5	8138D150			RSB5550	CW15	WP032	2/1		
			55.94	+2.0	8138D200			RSB5600	CW15	WP032	2/1		
RM125	89-99	123	53.95	Std.	8055DA	-	29.50	RSB5400	CW15	WP032	2	D2027	P2015 / P2014 / P2013
			53.96	+0.01	8055DB			RSB5400	CW15	WP032	2		
			53.97	+0.02	8055DC			RSB5400	CW15	WP032	2		
			54.45	+0.5	8055D050			RSB5450	CW15	WP032	2		
			54.95	+1.0	8055D100			RSB5500	CW15	WP032	2		
			55.45	+1.5	8055D150			RSB5550	CW15	WP032	2		
55.95	+2.0	8055D200	RSB5600	CW15	WP032	2							
RM125	00-03	125	53.95	Std.	8061DA	-	29.50	RSB5400	CW15	WP032	2	D2027	P2013
			53.96	+0.01	8061DB			RSB5400	CW15	WP032	2		
			53.97	+0.02	8061DC			RSB5400	CW15	WP032	2		
			54.45	+0.5	8061D050			RSB5450	CW15	WP032	2		
			54.95	+1.0	8061D100			RSB5500	CW15	WP032	2		
			55.45	+1.5	8061D150			RSB5550	CW15	WP032	2		
55.95	+2.0	8061D200	RSB5600	CW15	WP032	2							
RM125	04-09	125	53.95	Std.	8098DA	-	29.50	RSB5400	CW15	WP032	2	D2027	P2016
			53.96	+0.01	8098DB			RSB5400	CW15	WP032	2		
			53.97	+0.02	8098DC			RSB5400	CW15	WP032	2		
			55.95	+2.0	8098D200			RSB5600	CW15	WP032	2		
TS125 & RV125 & TS125ER & TS125X	71-81	125	55.94	Std.	8146DA	-	29	RDB5600	CW14	WP025	2/1	-	-
	74-78		56.44	+0.5	8146D050			RDB5650	CW14	WP025	2/1		
	79-81		56.94	+1.0	8146D100			RDB5700	CW14	WP025	2/1		
	84-89		57.44	+1.5	8146D150			RDB5750	CW14	WP025	2/1		
			57.94	+2.0	8146D200			RDB5800	CW14	WP025	2/1		





## SUZUKI 2-stroke



Model	Years	Displ. (cc)	Piston Size (mm)	Over-sizes (mm)	Piston Kit Part No.	Dome Volume (cm <sup>3</sup> )	Comp. Height (mm)	set includes				extra parts	
								Ring Set Part No.	Clip Part No.	Pin Part No.	Price-code	Top End Gasket Kit	Wössner Connecting Rods
RG125	85-91	125	53.94	Std.	8028DA	-	28	RDB5400	CW14	WP025	2/1	-	-
			54.44	+0.5	8028D050			RDB5450	CW14	WP025	2/1		
			54.94	+1.0	8028D100			RDB5500	CW14	WP025	2/1		
			55.44	+1.5	8028D150			RDB5550	CW14	WP025	2/1		
			55.94	+2.0	8028D200			RDB5600	CW14	WP025	2/1		
TSR125	89-95	125	55.94	Std.	8009DA	-	28.50	RDB5600	CW16	WP036	2	-	-
			56.44	+0.5	8009D050			RDB5650	CW16	WP036	2		
			56.94	+1.0	8009D100			RDB5700	CW16	WP036	2		
			57.44	+1.5	8009D150			RDB5750	CW16	WP036	2		
			57.94	+2.0	8009D200			RDB5800	CW16	WP036	2		
PE175	80-84	172	61.94	Std.	8193DA	-	31.80	RDB6200	CW16	WP041	3/1	-	-
			62.44	+0.5	8193D050			RDB6250	CW16	WP041	3/1		
			62.94	+1.0	8193D100			RDB6300	CW16	WP041	3/1		
			63.44	+1.5	8193D150			RDB6350	CW16	WP041	3/1		
			63.94	+2.0	8193D200			RDB6400	CW16	WP041	3/1		
TSR200	all	200	66.93	+1.0	8046D100	-	28.50	RDB6700	CW18	WP033	3	-	-
TS250	84-85	249	69.94	Std.	8204DA	-	33	RDB7000	CW18	WP033	3/1	-	-
			70.44	+0.5	8204D050			RDB7050	CW18	WP033	3/1		
			70.94	+1.0	8204D100			RDB7100	CW18	WP033	3/1		
			71.44	+1.5	8204D150			RDB7150	CW18	WP033	3/1		
			71.94	+2.0	8204D200			RDB7200	CW18	WP033	3/1		
RM250 & PE250	77-81	246	66.94	Std.	8194DA	-	37	RDB6700	CW18	WP033	3/1	-	-
			67.44	+0.5	8194D050			RDB6750	CW18	WP033	3/1		
			67.94	+1.0	8194D100			RDB6800	CW18	WP033	3/1		
			68.44	+1.5	8194D150			RDB6850	CW18	WP033	3/1		
			68.94	+2.0	8194D200			RDB6900	CW18	WP033	3/1		
RM250	82-85	246	69.94	Std.	8159DA	-	32.80	RSB7000	CW18	WP033	3/1	-	-
			70.44	+0.5	8159D050			RSB7050	CW18	WP033	3/1		
			70.69	+0.75	8159D075			RSB7075	CW18	WP033	3/1		
			70.94	+1.0	8159D100			RSB7100	CW18	WP033	3/1		
			71.44	+1.5	8159D150			RSB7150	CW18	WP033	3/1		
			71.94	+2.0	8159D200			RSB7200	CW18	WP033	3/1		





## SUZUKI 2-stroke



					set includes							extra parts	
													
Model	Years	Displ. (cc)	Piston Size (mm)	Over-sizes (mm)	Piston Kit Part No.	Dome Volume (cm <sup>3</sup> )	Comp. Height (mm)	Ring Set Part No.	Clip Part No.	Pin Part No.	Price-code	Top End Gasket Kit	Wössner Connecting Rods
RM250	86	246	66.94	Std.	8158DA	-	37	RSB6700	CW18	WP033	3/1	-	-
			67.44	+0.5	8158D050			RSB6750	CW18	WP033	3/1		
			67.94	+1.0	8158D100			RSB6800	CW18	WP033	3/1		
			68.44	+1.5	8158D150			RSB6850	CW18	WP033	3/1		
			68.94	+2.0	8158D200			RSB6900	CW18	WP033	3/1		
RM250	87-88	246	66.94	Std.	8157DA	-	37	RSB6700	CW18	WP033	3/1	-	P2027
			67.19	+0.25	8157D025			RSB6725	CW18	WP033	3/1		
			67.44	+0.5	8157D050			RSB6750	CW18	WP033	3/1		
			67.69	+0.75	8157D075			RSB6775	CW18	WP033	3/1		
			67.94	+1.0	8157D100			RSB6800	CW18	WP033	3/1		
			68.19	+1.25	8157D125			RSB6825	CW18	WP033	3/1		
			68.44	+1.5	8157D150			RSB6850	CW18	WP033	3/1		
			68.94	+2.0	8157D200			RSB6900	CW18	WP033	3/1		
RM250 & RMX250	89-95	246	66.94	Std.	8022DA	-	37	RDB6700	CW18	WP033	3	D2028 / D2029	P2027
			66.95	+0.01	8022DB			RDB6700	CW18	WP033	3		
			66.96	+0.02	8022DC			RDB6700	CW18	WP033	3		
			67.44	+0.5	8022D050			RDB6750	CW18	WP033	3		
			67.94	+1.0	8022D100			RDB6800	CW18	WP033	3		
			68.94	+2.0	8022D200			RDB6900	CW18	WP033	3		
RM250	96-97	249	66.34	Std.	8058DA	-	38	RDB6640	CW18	WP033	3/1	D2030	P2026
			66.35	+0.01	8058DB			RDB6640	CW18	WP033	3/1		
			66.36	+0.02	8058DC			RDB6640	CW18	WP033	3/1		
RM250	98	249	66.34	Std.	8140DA	-	38	RDB6640	CW18	WP033	3/1	D2030	P2026
			66.35	+0.01	8140DB			RDB6640	CW18	WP033	3/1		
			66.36	+0.02	8140DC			RDB6640	CW18	WP033	3/1		
			68.44	+2.1	8140D210			RDB6850	CW18	WP033	3/1		
RM250	99	249	66.34	Std.	8058DA	-	38	RDB6640	CW18	WP033	3/1	D2031	P2026
			66.35	+0.01	8058DB			RDB6640	CW18	WP033	3/1		
			66.36	+0.02	8058DC			RDB6640	CW18	WP033	3/1		

## SUZUKI 2-stroke

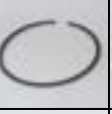

					set includes							extra parts		
														
Model	Years	Displ. (cc)	Piston Size (mm)	Over-sizes (mm)	Piston Kit Part No.	Dome Volume (cm <sup>3</sup> )	Comp. Height (mm)	Ring Set Part No.	Clip Part No.	Pin Part No.	Price-code	Top End Gasket Kit	Wössner Connecting Rods	
RM250	00-02	249	66.34	Std.	8059DA	-	38	RDB6640	CW18	WP033	3/1	D2031 / D2032	P2026	
			66.35	+0.01	8059DB			RDB6640	CW18	WP033	3/1			
			66.36	+0.02	8059DC			RDB6640	CW18	WP033	3/1			
RM250	03-09	249	66.34	Std.	8086DA	-	38	RDB6640	CW18	WP033	3	D2033	P2025	
			66.35	+0.01	8086DB			RDB6640	CW18	WP033	3			
			66.36	+0.02	8086DC			RDB6640	CW18	WP033	3			
RM250 Single Ring	03-09	249	66.34	Std.	8087DA	-	38	RSB6640	CW18	WP033	3/1	D2033	P2025	
			66.35	+0.01	8087DB			RSB6640	CW18	WP033	3/1			
			66.36	+0.02	8087DC			RSB6640	CW18	WP033	3/1			
RGV & RGV250 Single Ring	92-98	349	55.95	Std.	8039DA	-	28.50	RSB5600	CW16	WP036	3	-	-	
			55.96	+0.01	8039DB			RSB5600	CW16	WP036	3			
			55.97	+0.02	8039DC			RSB5600	CW16	WP036	3			
			56.45	+0.5	8039D050			RSB5650	CW16	WP036	3			
			56.95	+1.0	8039D100			RSB5700	CW16	WP036	3			
TSX250 & RH240 & TSX240	86-87	250	69.93	Std.	8013DA	-	31	RDB7000	CW18	WP033	3/1	-	-	
			70.43	+0.5	8013D050			RDB7050	CW18	WP033	3/1			
			70.93	+1.0	8013D100			RDB7100	CW18	WP033	3/1			
			71.43	+1.5	8013D150			RDB7150	CW18	WP033	3/1			
			71.93	+2.0	8013D200			RDB7200	CW18	WP033	3/1			



Ryan Koontz, # 440  
an Suzuki RMZ 250/450  
AMA National SX/MX Series 2006/07

## SUZUKI-ATV 2-stroke



Model	Years	Displ. (cc)	Piston Size (mm)	Over-sizes (mm)	Piston Kit Part No.	Dome Volume (cm <sup>3</sup> )	Comp. Height (mm)	set includes				extra parts	
								Ring Set Part No.	Clip Part No.	Pin Part No.	Price-code	Top End Gasket Kit	Wössner Connecting Rods
LT250RF, RG Must use stock thrust washers	85-86	-	69.94	Std.	8257DA	-	-	RDB7000	CW18	-	3	-	P2045
			70.44	+0.5	8257D050			RDB7050	CW18	-	3		
			70.94	+1.0	8257D100			RDB7100	CW18	-	3		
			71.44	+1.5	8257D150			RDB7150	CW18	-	3		
			71.94	+2.0	8257D200			RDB7200	CW18	-	3		
LT250 Must use stock thrust washers	87	-	66.94	Std.	8258DA	-	-	RDB6700	CW18	-	3	-	P2045
			67.44	+0.5	8258D050			RDB6750	CW18	-	3		
			67.94	+1.0	8258D100			RDB6800	CW18	-	3		
			68.44	+1.5	8258D150			RDB6850	CW18	-	3		
			68.94	+2.0	8258D200			RDB6900	CW18	-	3		
LT250 Must use stock thrust washers	88-92	-	66.94	Std.	8259DA	-	-	RDB6700	CW18	-	3	-	P2045
			67.44	+0.5	8259D050			RDB6750	CW18	-	3		
			67.69	+0.75	8259D075			RDB6775	CW18	-	3		
			67.94	+1.0	8259D100			RDB6800	CW18	-	3		
			68.19	+1.25	8259D125			RDB6825	CW18	-	3		
			68.44	+1.5	8259D150			RDB6850	CW18	-	3		
LT500R	87	-	85.94	Std.	8260DA	-	-	RDC8600	CW18	-	6	-	P2046
			86.44	+0.5	8260D050			RDC8650	CW18	-	6		
			86.94	+1.0	8260D100			RDC8700	CW18	-	6		
			87.44	+1.5	8260D150			RDC8750	CW18	-	6		
			87.94	+2.0	8260D200			RDC8800	CW18	-	6		
			88.44	+2.5	8260D250			RDC8850	CW18	-	6		
			88.94	+3.0	8260D300			RDC8900	CW18	-	6		
			89.44	+3.5	8260D350			RDC8950	CW18	-	6		
LT500R	88-92	-	85.94	Std.	8261DA	-	-	RDC8600	CW18	-	6	-	P2046
			86.44	+0.5	8261D050			RDC8650	CW18	-	6		
			86.94	+1.0	8261D100			RDC8700	CW18	-	6		
			87.44	+1.5	8261D150			RDC8750	CW18	-	6		
			87.94	+2.0	8261D200			RDC8800	CW18	-	6		
			88.44	+2.5	8261D250			RDC8850	CW18	-	6		
			88.94	+3.0	8261D300			RDC8900	CW18	-	6		
			89.44	+3.5	8261D350			RDC8950	CW18	-	6		



## SUZUKI 4-stroke



Model	Years	Displ. (cc)	Piston Size (mm)	Over-sizes (mm)	Piston Kit Part No.	Dome Volume (cm <sup>3</sup> )	Comp. Height (mm)	set includes				extra parts	
								Ring Set Part No.	Clip Part No.	Pin Part No.	Price-code	Top End Gasket Kit	Wössner Connecting Rods
DRZ110	04-05	118	53.95	+1.0	8676D100	+1.7	19.70	540XKS	CW13	WP088	4/1	-	-
			54.45	+1.5	8676D150			545XKS	CW13	WP088	4/1		
			54.95	+2.0	8676D200			550XKS	CW13	WP088	4/1		
			56.95	+4.0	8676D400			570XKS	CW13	WP088	4/1		
DRZ125	02-09	125	56.95	Std.	8677DA	-	19.70	570XKS	CW14	WP058	4/1	-	-
			57.45	+0.50	8677D050			575XKS	CW14	WP058	4/1		
			57.95	+1.0	8677D100			580XKS	CW14	WP058	4/1		
			58.95	+2.0	8677D200			590XKS	CW14	WP058	4/1		
			60.95	+4.0	8677D400			610XKS	CW14	WP058	4/1		
DRZ250 Hi-Compr. 11.5:1	02-09	249	72.95	Std.	8678DA	-	-	730XDS	CW19	WP028	4/1	-	-
			300	+7.0	8678D700			800XDS-3	CW19	WP028	4/1		
RM-Z250 12.1:1	04-06	249	76.96	Std.	8582DA	-5.85	19.60	770XAS-3	CW16	WP059	5	D4013	P4002
			76.97	+0.01	8582DB			770XAS-3	CW16	WP059	5		
			76.98	+0.02	8582DC			770XAS-3	CW16	WP059	5		
			82.96	+6.0	8582D600			830XSY	CW16	WP059	7		
RM-Z250 13.5:1 Pro Series	04-06	249	76.96	Std.	8661DA	-4	19.60	770XAS-3	CW16	WP059	5/1	D4013	P4002
			76.97	+0.01	8661DB			770XAS-3	CW16	WP059	5/1		
			76.98	+0.02	8661DC			770XAS-3	CW16	WP059	5/1		
RM-Z250 13.4:1	07-09	249	76.96	Std.	8666DA	-3.27	19.60	770XAS-3	CW16	WP059	5	D4022	P4004
			76.97	+0.01	8666DB			770XAS-3	CW16	WP059	5		
			76.98	+0.02	8666DC			770XAS-3	CW16	WP059	5		
RM-Z250 13.9:1 Pro Series	07-09	249	76.96	Std.	8672DA	-2.5	19.60	770XAS-3	CW16	WP070	5	D4022	P4004
			76.97	+0.01	8672DB			770XAS-3	CW16	WP070	5		
			76.98	+0.02	8672DC			770XAS-3	CW16	WP070	5		
RM-Z250 13.6:1	10	249	76.96	Std.	8781DA	-2.6	19.60	770XAS-2	CW16	WP070	5	-	-
			76.97	+0.01	8781DB			770XAS-2	CW16	WP070	5		
			76.98	+0.02	8781DC			770XAS-2	CW16	WP070	5		
RM-Z250 14:1 Pro Series	10	249	76.96	Std.	8795DA	-2.1	19.60	770XAS-2	CW16	WP070	5	-	-
			76.97	+0.01	8795DB			770XAS-2	CW16	WP070	5		
			76.98	+0.02	8795DC			770XAS-2	CW16	WP070	5		
DR350R & S & SE	90-99	349	78.94	Std.	8600DA	-	25	790XDS-3	CW20	WP029	5/1	-	-
			79.94	+1.0	8600D100			800XDS-3	CW20	WP029	5/1		
			80.94	+2.0	8600D200			810XSY	CW20	WP029	5/1		
			81.94	+3.0	8600D300			820XSY	CW20	WP029	5/1		
			82.94	+4.0	8600D400			830XSY	CW20	WP029	5/1		





## SUZUKI 4-stroke



Model	Years	Displ. (cc)	Piston Size (mm)	Over-sizes (mm)	Piston Kit Part No.	set includes						extra parts	
						Dome Volume (cm <sup>3</sup> )	Comp. Height (mm)	Ring Set Part No.	Clip Part No.	Pin Part No.	Price-code	Top End Gasket Kit	Wössner Connecting Rods
DR-Z400E & S 12.0:1	00-07	398	89.94	Std.	8563DA	-2	25.30	900XSY	CW20	WP029	7	D4023	P4009
		439	89.95	+0.01	8563DB			900XSY	CW20	WP029	7		
		450	89.96	+0.02	8563DC			900XSY	CW20	WP029	7		
		93.94	+4.0	8563D400	940XSY			CW20	WP029	7			
		95.44	+5.5	8563D550	955XSY			CW20	WP029	7			
DR-Z400E & S 13.5:1 Pro Series 2 Ring	00-07	398	89.94	Std.	8567DA	-	25.30	900XSY	CW20	WP029	7	D4023	P4009
		89.95	+0.01	8567DB	900XSY			CW20	WP029	7			
		89.96	+0.02	8567DC	900XSY			CW20	WP029	7			
		95.44	+5.5	8567D550	955XSY			CW20	WP029	7			
		RM-Z450 12.0:1	05-07	449	95.46			Std.	8606DA	-3.14	22.30		
95.47	+0.01			8606DB	955XSY	CW19	WP037	7					
95.48	+0.02			8606DC	955XSY	CW19	WP037	7					
97.46	+2.0			8606D200	975XSY	CW19	WP037	7					
99.96	+4.5			8606D450	1000XSY	CW19	WP037	7					
RM-Z450 13.5:1 Pro Series 2 Ring	05-07	449	95.46	Std.	8616DA	+0.25	22.30	955ADS-2	CW19	WP037	7/1	D4024 / D4025	P4012
		95.47	+0.01	8616DB	955ADS-2			CW19	WP037	7/1			
		95.48	+0.02	8616DC	955ADS-2			CW19	WP037	7/1			
		97.46	+2.0	8616D200	975ADS			CW19	WP037	7/1			
		RM-Z450 12.2:1	08-10	449	95.96			Std.	8716DA	-0.8	23.10		
95.97	+0.01			8716DB	960ADS-2	CW19	WP037	7					
95.98	+0.02			8716DC	960ADS-2	CW19	WP037	7					
RM-Z450 13.5:1 Pro Series 2 Ring	08-10	449	95.96	Std.	8717DA	+3.4	23.10	960ADS-2	CW19	WP071	7/1	D4026	P4013
		95.97	+0.01	8717DB	960ADS-2			CW19	WP071	7/1			
		95.98	+0.02	8717DC	960ADS-2			CW19	WP071	7/1			
DR & SP600 Djebel 10.0:1	85-89	589	94.94	+1.0	8503DA	+6.1	28.90	950XSY-3	CW23	WP024	7	-	-
		95.94	+2.0	8503D100	960XSY-3			CW23	WP024	7			
		96.44	+2.5	8503D150	965XSY-3			CW23	WP024	7			
		96.94	+3.0	8503D200	970XSY-3			CW23	WP024	7			
		DR650R & S & SE 10.0:1	90-95	641	94.94			Std.	8503DA	+6.1	28.90		
95.94	+1.0			8503D100	960XSY-3	CW23	WP024	7					
96.44	+2.5			8503D150	965XSY-3	CW23	WP024	7					
96.94	+2.0			8503D200	970XSY-3	CW23	WP024	7					
DR650SE Hi-Compr.	96-09			641	99.94	Std.	8591DA	-	28.70			1000XSY	CW23
		99.95	+0.01	8591DB	1000XSY	CW23	WP024			7/1			
		99.96	+0.02	8591DC	1000XSY	CW23	WP024			7/1			
		100.94	+1.0	8591D100	1010XSY-3	CW23	WP024			7/1			
		101.94	+2.0	8591D200	1020XSU	CW23	WP024			7/1			

## SUZUKI-ATV 4-stroke



					set includes							extra parts	
													
Model	Years	Displ. (cc)	Piston Size (mm)	Over-sizes (mm)	Piston Kit Part No.	Dome Volume (cm <sup>3</sup> )	Comp. Height (mm)	Ring Set Part No.	Clip Part No.	Pin Part No.	Price-code	Top End Gasket Kit	Wössner Connecting Rods
LT-Z400 12.0:1	02-06	398	89.94	Std.	8563DA	-2	25.30	900XSX	CW20	WP029	7	D4023	P4009
		440	89.95	+0.01	8563DB			900XSX	CW20	WP029	7		
		450	89.96	+0.02	8563DC			900XSX	CW20	WP029	7		
		93.94	+4.0	8563D400	940XSX			CW20	WP029	7			
		95.44	+5.5	8563D550	955XSX			CW20	WP029	7			
LT-Z400 13.5:1 Pro Series 2 Ring	02-06	398	89.94	Std.	8567DA	-	25.30	900XSX	CW20	WP029	7	D4023	P4009
		89.95	+0.01	8567DB	900XSX			CW20	WP029	7			
		89.96	+0.02	8567DC	900XSX			CW20	WP029	7			
		95.44	+5.5	8567D550	955XSX			CW20	WP029	7			
LTR450 11.7:1	06-09	450	95.45	Std.	8667DA	-3.0	24.50	955XSX	CW19	WP037	7	D4027	P4011
		95.46	+0.01	8667DB	955XSX			CW19	WP037	7			
		95.47	+0.02	8667DC	955XSX			CW19	WP037	7			
		97.95	+2.5	8667D250	980XSX			CW19	WP037	7			
		99.95	+4.5	8667D450	1000XSX			CW19	WP037	7	D4028		
LTR450 Pro Series 13.3:1	06-09	450	95.45	Std.	8699DA	+2.3	24.50	955ADS-2	CW19	WP037	7	D4027	P4011
		95.46	+0.01	8699DB	955ADS-2	CW19		WP037	7				
		95.47	+0.02	8699DC	955ADS-2	CW19		WP037	7				
		97.95	+2.5	8699D250	980ADS-2	CW19		WP037	7				
		99.95	+4.5	8699D450	1000ADS	CW19		WP037	7				



## TM 2-stroke







					set includes							extra parts		
Model	Years	Displ. (cc)	Piston Size (mm)	Over-sizes (mm)	Piston Kit Part No.	Dome Volume (cm <sup>3</sup> )	Comp. Height (mm)	Ring Set Part No.	Clip Part No.	Pin Part No.	Price-code	Top End Gasket Kit	Wössner Connecting Rods	
125 Cross & Enduro	97-09	125	53.94	Std.	8135DA	-	29	RSB5400	CW15	WP032	2	-	-	
			53.95	+0.01	8135DB			RSB5400	CW15	WP032	2			
			53.96	+0.02	8135DC			RSB5400	CW15	WP032	2			
			53.97	+0.03	8135DD			RSB5400	CW15	WP032	2			
			53.98	+0.04	8135DE			RSB5400	CW15	WP032	2			
250 Cross & Enduro (Flat)	94-09	249	66.33	Std.	8136DA	-	38	RDB6640	CW18	WP033	3/1	-	-	
			66.34	+0.01	8136DB			RDB6640	CW18	WP033	3/1			
			66.35	+0.02	8136DC			RDB6640	CW18	WP033	3/1			
			66.36	+0.03	8136DD			RDB6640	CW18	WP033	3/1			
250 Cross & Enduro (Domed)	99-09	249	66.33	Std.	8137DA	-	38	RSB6640	CW18	WP033	3/1	-	-	
			66.34	+0.01	8137DB			RSB6640	CW18	WP033	3/1			
			66.35	+0.02	8137DC			RSB6640	CW18	WP033	3/1			
			66.36	+0.03	8137DD			RSB6640	CW18	WP033	3/1			
300 Cross & Enduro	97-01	300	71.93	Std.	8054DA	-	37	RSB7200	CW18	WP033	6/1	-	-	
			71.94	+0.01	8054DB			RSB7200	CW18	WP033	6/1			
			71.95	+0.02	8054DC			RSB7200	CW18	WP033	6/1			
300 Cross & Enduro with exhaust bar	01-09	300	71.93	Std.	8213DA	-	38	RSB7200	CW18	WP033	6/1	-	-	
			71.94	+0.01	8213DB			RSB7200	CW18	WP033	6/1			
			71.95	+0.02	8213DC			RSB7200	CW18	WP033	6/1			



## TM 4-stroke







					set includes							extra parts	
													
Model	Years	Displ. (cc)	Piston Size (mm)	Over-sizes (mm)	Piston Kit Part No.	Dome Volume (cm <sup>3</sup> )	Comp. Height (mm)	Ring Set Part No.	Clip Part No.	Pin Part No.	Price-code	Top End Gasket Kit	Wössner Connecting Rods
250 F Cross & Enduro	06-09	249	76.96	Std.	8653DA	-	22.40	770XAS-3	CW16	WP059	5/1	-	-
			76.97	+0.01	8653DB			770XAS-3	CW16	WP059	5/1		
			76.98	+0.02	8653DC			770XAS-3	CW16	WP059	5/1		
450 Cross & Enduro	04	449	94.96	Std.	8586DA	-	25.50	950ADS-2	CW19	WP037	7/1	-	-
			94.97	+0.01	8586DB			950ADS-2	CW19	WP037	7/1		
			94.98	+0.02	8586DC			950ADS-2	CW19	WP037	7/1		
450 Cross & Enduro	05-09	449	94.96	Std.	8714DA	-11.40	25.50	950ADS-2	CW19	WP037	7/1	-	-
			94.97	+0.01	8714DB			950ADS-2	CW19	WP037	7/1		
			94.98	+0.02	8714DC			950ADS-2	CW19	WP037	7/1		
530 Cross & Enduro	03-09	527	97.95	Std.	8654DA	-	26.80	980ADS-2	CW20	WP038	7/1	-	-
			97.96	+0.01	8654DB			980ADS-2	CW20	WP038	7/1		
			97.97	+0.02	8654DC			980ADS-2	CW20	WP038	7/1		



## VOR 4-stroke



					set includes							extra parts	
													
Model	Years	Displ. (cc)	Piston Size (mm)	Over-sizes (mm)	Piston Kit Part No.	Dome Volume (cm <sup>3</sup> )	Comp. Height (mm)	Ring Set Part No.	Clip Part No.	Pin Part No.	Price-code	Top End Gasket Kit	Wössner Connecting Rods
450 Cross & Enduro	04-07	449	96.94	Std.	8589DA	-	21.80	970XS	CW20	WP038	7/1	-	-
			96.95	+0.01	8589DB			970XS	CW20	WP038	7/1		
			96.96	+0.02	8589DC			970XS	CW20	WP038	7/1		
503 Cross & Enduro	00-02	503	94.94	Std.	8554DA	-	22	950XS	CW20	WP038	7/1	-	-
			94.95	+0.01	8554DB			950XS	CW20	WP038	7/1		
			94.96	+0.02	8554DC			950XS	CW20	WP038	7/1		
530 Cross & Enduro	02-07	530	96.94	Std.	8555DA	+4.2	22	970XS	CW20	WP038	7/1	-	-
			96.95	+0.01	8555DB			970XS	CW20	WP038	7/1		
			96.96	+0.02	8555DC			970XS	CW20	WP038	7/1		







## YAMAHA 2-stroke



Model	Years	Displ. (cc)	Piston Size (mm)	Over-sizes (mm)	Piston Kit Part No.	Dome Volume (cm <sup>3</sup> )	Comp. Height (mm)	set includes				extra parts	
								Ring Set Part No.	Clip Part No.	Pin Part No.	Price-code	Top End Gasket Kit	Wössner Connecting Rods
PW80	thru 2006	-	46.95	Std.	8233DA	-	29.50	RSB4700	CW12	WP091	1/1	-	-
			47.45	+0.5	8233D050			RSB4750	CW12	WP091	1/1		
			47.95	+1.0	8233D100			RSB4800	CW12	WP091	1/1		
			48.45	+1.5	8233D150			RSB4850	CW12	WP091	1/1		
			48.95	+2.0	8233D200			RSB4900	CW12	WP091	1/1		
YZ80	76-80	79	48.95	Std.	8183DA	-	29.50	RSB4900	CW12	WP091	1/1	-	-
			49.45	+0.5	8183D050			RSB4950	CW12	WP091	1/1		
			49.95	+1.0	8183D100			RSB5000	CW12	WP091	1/1		
			50.45	+1.5	8183D150			RSB5050	CW12	WP091	1/1		
			50.95	+2.0	8183D200			RSB5100	CW12	WP091	1/1		
YZ80	81	79	48.95	Std.	8184DA	-	24.20	RSB4900	CW12	WP091	1/1	-	-
			49.45	+0.5	8184D050			RSB4950	CW12	WP091	1/1		
			49.95	+1.0	8184D100			RSB5000	CW12	WP091	1/1		
			50.45	+1.5	8184D150			RSB5050	CW12	WP091	1/1		
			50.95	+2.0	8184D200			RSB5100	CW12	WP091	1/1		
YZ80	82-83	79	46.95	Std.	8185DA	-	27.20	RSB4700	CW12	WP091	1/1	-	-
			47.45	+0.5	8185D050			RSB4750	CW12	WP091	1/1		
			47.95	+1.0	8185D100			RSB4800	CW12	WP091	1/1		
			48.45	+1.5	8185D150			RSB4850	CW12	WP091	1/1		
			48.95	+2.0	8185D200			RSB4900	CW12	WP091	1/1		
YZ80	84	82	47.95	Std.	8214DA	-	27	RSB4800	CW12	WP091	1/1	-	-
			48.45	+0.5	8214D050			RSB4850	CW12	WP091	1/1		
			48.95	+1.0	8214D100			RSB4900	CW12	WP091	1/1		
			49.49	+1.5	8214D150			RSB4950	CW12	WP091	1/1		
			49.95	+2.0	8214D200			RSB5000	CW12	WP091	1/1		
YZ80	85-87	82	47.95	Std.	8186DA	-	26.80	RSB4800	CW12	WP091	1	-	-
			48.45	+0.5	8186D050			RSB4850	CW12	WP091	1		
			48.95	+1.0	8186D100			RSB4900	CW12	WP091	1		
			49.45	+1.5	8186D150			RSB4950	CW12	WP091	1		
			49.95	+2.0	8186D200			RSB5000	CW12	WP091	1		

## YAMAHA 2-stroke



					set includes							extra parts	
													
Model	Years	Displ. (cc)	Piston Size (mm)	Over-sizes (mm)	Piston Kit Part No.	Dome Volume (cm <sup>3</sup> )	Comp. Height (mm)	Ring Set Part No.	Clip Part No.	Pin Part No.	Price-code	Top End Gasket Kit	Wössner Connecting Rods
YZ80	88-92	82	47.95	Std.	8187DA	-	27	RSB4800	CW12	WP091	1/1	-	-
			48.45	+0.5	8187D050			RSB4850	CW12	WP091	1/1		
			48.95	+1.0	8187D100			RSB4900	CW12	WP091	1/1		
			49.45	+1.5	8187D150			RSB4950	CW12	WP091	1/1		
			49.95	+2.0	8187D200			RSB5000	CW12	WP091	1/1		
YZ80 U.S Bore	93-01	82	46.95	Std.	8188DA	-	26	RSB4700	CW14	WP058	1/1	-	P2008
			46.96	+0.01	8188DB			RSB4700	CW14	WP058	1/1		
			46.97	+0.02	8188DC			RSB4700	CW14	WP058	1/1		
			46.98	+0.03	8188DD			RSB4700	CW14	WP058	1/1		
			47.45	+0.5	8188D050			RSB4750	CW14	WP058	1/1		
			47.95	+1.0	8188D100			RSB4800	CW14	WP058	1/1		
			48.45	+1.5	8188D150			RSB4850	CW14	WP058	1/1		
			48.95	+2.0	8188D200			RSB4900	CW14	WP058	1/1		
YZ80 International Bore	93-01	82	45.95	Std.	8239DA	-	26	RSB4600	CW14	WP058	1	-	P2008
			46.45	+0.5	8239D050			RSB4650	CW14	WP058	1		
			46.95	+1.0	8239D100			RSB4700	CW14	WP058	1		
			47.45	+1.5	8239D150			RSB4750	CW14	WP058	1		
			47.95	+2.0	8239D200			RSB4800	CW14	WP058	1		
YZ85	02-09	85	47.45	Std.	8104DA	-	26	RSB4750	CW14	WP058	1	D2034	P2008
			47.46	+0.01	8104DB			RSB4750	CW14	WP058	1		
			47.47	+0.02	8104DC			RSB4750	CW14	WP058	1		
125DTE & DTF & DTMX & DTLC	75-92	124	55.94	Std.	8003DA	-	29.90	RDB5600	CW16	WP036	2	-	-
			56.19	+0.25	8003D025			RDB5625	CW16	WP036	2		
			56.44	+0.5	8003D050			RDB5650	CW16	WP036	2		
			56.69	+0.75	8003D075			RDB5675	CW16	WP036	2		
			56.94	+1.0	8003D100			RDB5700	CW16	WP036	2		
			57.19	+1.25	8003D125			RDB5725	CW16	WP036	2		
			57.44	+1.5	8003D150			RDB5750	CW16	WP036	2		







## YAMAHA 2-stroke



Model	Years	Displ. (cc)	Piston Size (mm)	Over-sizes (mm)	Piston Kit Part No.	Dome Volume (cm <sup>3</sup> )	Comp. Height (mm)	set includes					extra parts	
								Ring Set Part No.	Clip Part No.	Pin Part No.	Price-code	Top End Gasket Kit	Wössner Connecting Rods	
DT125R & E & X domed	91-06	124	55.94	Std.	8002DA	-	29.90	RDB5600	CW16	WP036	2	D2035		
			56.19	+0.25	8002D025			RDB5625	CW16	WP036	2			
			56.44	+0.5	8002D050			RDB5650	CW16	WP036	2			
			56.69	+0.75	8002D075			RDB5675	CW16	WP036	2			
			56.94	+1.0	8002D100			RDB5700	CW16	WP036	2			
			57.19	+1.25	8002D125			RDB5725	CW16	WP036	2			
			57.44	+1.5	8002D150			RDB5750	CW16	WP036	2	D2036		
			57.94	+2.0	8002D200			RDB5800	CW16	WP036	2			
			58.44	+2.5	8002D250			RDB5850	CW16	WP036	2			
			58.94	+3.0	8002D300			RDB5900	CW16	WP036	2			
			59.94	+4.0	8002D400			RDB6000	CW16	WP036	2			
			60.94	+5.0	8002D500			RDB6100	CW16	WP036	2			
TZR125R & TDR125 Flat top	92-98	124	55.94	Std.	8006DA	-	29.90	RDB5600	CW16	WP036	2			
			55.95	+0.01	8006DB			RDB5600	CW16	WP036	2			
			55.96	+0.02	8006DC			RDB5600	CW16	WP036	2			
			56.19	+0.25	8006D025			RDB5625	CW16	WP036	2			
			56.44	+0.5	8006D050			RDB5650	CW16	WP036	2			
			56.69	+0.75	8006D075			RDB5675	CW16	WP036	2			
			56.94	+1.0	8006D100			RDB5700	CW16	WP036	2			
			57.19	+1.25	8006D125			RDB5725	CW16	WP036	2			
			57.44	+1.5	8006D150			RDB5750	CW16	WP036	2			
			57.69	+1.75	8006D175			RDB5775	CW16	WP036	2			
			57.94	+2.0	8006D200			RDB5800	CW16	WP036	2			
			58.44	+2.5	8006D250			RDB5850	CW16	WP036	2			
YZ125	76-82	123	55.94	Std.	8115DA	-	30	RSB5600	CW16	WP036	2/1			
			55.95	+0.01	8115DB			RSB5600	CW16	WP036	2/1			
			56.19	+0.25	8115D025			RSB5625	CW16	WP036	2/1			
			56.44	+0.5	8115D050			RSB5650	CW16	WP036	2/1			
			56.69	+0.75	8115D075			RSB5675	CW16	WP036	2/1			
			56.94	+1.0	8115D100			RSB5700	CW16	WP036	2/1			
			57.44	+1.5	8115D150			RSB5750	CW16	WP036	2/1			
			57.94	+2.0	8115D200			RSB5800	CW16	WP036	2/1			

## YAMAHA 2-stroke



					set includes							extra parts	
													
Model	Years	Displ. (cc)	Piston Size (mm)	Over-sizes (mm)	Piston Kit Part No.	Dome Volume (cm <sup>3</sup> )	Comp. Height (mm)	Ring Set Part No.	Clip Part No.	Pin Part No.	Price-code	Top End Gasket Kit	Wössner Connecting Rods
YZ125	83	123	55.94	Std.	8119DA	-	30.80	RSB5600	CW16	WP036	2/1	-	-
			55.95	+0.01	8119DB			RSB5600	CW16	WP036	2/1		
			56.44	+0.5	8119D050			RSB5650	CW16	WP036	2/1		
			56.69	+0.75	8119D075			RSB5675	CW16	WP036	2/1		
			56.94	+1.0	8119D100			RSB5700	CW16	WP036	2/1		
			57.44	+1.5	8119D150			RSB5750	CW16	WP036	2/1		
			57.94	+2.0	8119D200			RSB5800	CW16	WP036	2/1		
YZ125	84	123	55.94	Std.	8120DA	-	30.80	RSB5600	CW16	WP036	2/1	-	-
			55.95	+0.01	8120DB			RSB5600	CW16	WP036	2/1		
			56.44	+0.5	8120D050			RSB5650	CW16	WP036	2/1		
			56.69	+0.75	8120D075			RSB5675	CW16	WP036	2/1		
			56.94	+1.0	8120D100			RSB5700	CW16	WP036	2/1		
			57.19	+1.25	8120D125			RSB5725	CW16	WP036	2/1		
			57.44	+1.5	8120D150			RSB5750	CW16	WP036	2/1		
57.94	+2.0	8120D200	RSB5800	CW16	WP036	2/1							
YZ125	85	123	55.94	Std.	8119DA	-	30.80	RSB5600	CW16	WP036	2/1	-	-
			55.95	+0.01	8119DB			RSB5600	CW16	WP036	2/1		
			56.44	+0.5	8119D050			RSB5650	CW16	WP036	2/1		
			56.69	+0.75	8119D075			RSB5675	CW16	WP036	2/1		
			56.94	+1.0	8119D100			RSB5700	CW16	WP036	2/1		
			57.44	+1.5	8119D150			RSB5750	CW16	WP036	2/1		
			57.94	+2.0	8119D200			RSB5800	CW16	WP036	2/1		
YZ125	86-88	123	55.94	Std.	8118DA	-	30	RSB5600	CW16	WP036	2/1	-	P2047
			55.95	+0.01	8118DB			RSB5600	CW16	WP036	2/1		
			56.19	+0.25	8118D025			RSB5625	CW16	WP036	2/1		
			56.44	+0.5	8118D050			RSB5650	CW16	WP036	2/1		
			56.69	+0.75	8118D075			RSB5675	CW16	WP036	2/1		
			56.94	+1.0	8118D100			RSB5700	CW16	WP036	2/1		
			57.19	+1.25	8118D125			RSB5725	CW16	WP036	2/1		
57.44	+1.5	8118D150	RSB5750	CW16	WP036	2/1							
57.94	+2.0	8118D200	RSB5800	CW16	WP036	2/1							



## YAMAHA 2-stroke



Model	Years	Displ. (cc)	Piston Size (mm)	Over-sizes (mm)	Piston Kit Part No.	Dome Volume (cm <sup>3</sup> )	Comp. Height (mm)	set includes				extra parts	
								Ring Set Part No.	Clip Part No.	Pin Part No.	Price-code	Top End Gasket Kit	Wössner Connecting Rods
YZ125	89	123	55.94	Std.	8131DA	-	28	RSB5600	CW16	WP036	2	-	P2047
			55.95	+0.01	8131DB			RSB5600	CW16	WP036	2		
			56.44	+0.5	8131D050			RSB5650	CW16	WP036	2		
			56.94	+1.0	8131D100			RSB5700	CW16	WP036	2		
YZ125	90-93	124	55.94	Std.	8114DA	-	28	RSB5600	CW16	WP036	2	-	P2047
			55.95	+0.01	8114DB			RSB5600	CW16	WP036	2		
			55.96	+0.02	8114DC			RSB5600	CW16	WP036	2		
			56.44	+0.5	8114D050			RSB5650	CW16	WP036	2		
			56.94	+1.0	8114D100			RSB5700	CW16	WP036	2		
			57.44	+1.5	8114D150			RSB5750	CW16	WP036	2		
57.94	+2.0	8114D200	RSB5800	CW16	WP036	2							
YZ125	94-96	124	53.94	Std.	8116DA	-	28	RSB5400	CW16	WP036	2	D2037	P2047
			53.95	+0.01	8116DB			RSB5400	CW16	WP036	2		
			54.44	+0.5	8116D050			RSB5450	CW16	WP036	2		
			54.94	+1.0	8116D100			RSB5500	CW16	WP036	2		
			55.94	+2.0	8116D200			RSB5600	CW16	WP036	2		
YZ125	97	124	53.94	Std.	8117DA	-	28	RSB5400	CW15	WP032	2/1	D2037	P2019
			53.95	+0.01	8117DB			RSB5400	CW15	WP032	2/1		
			53.96	+0.02	8117DC			RSB5400	CW15	WP032	2/1		
			55.94	+2.0	8117D200			RSB5600	CW15	WP032	2/1		
YZ & WR125	98-01	125	53.95	Std.	8091DA	-	28	RSB5400	CW15	WP032	2	D2037 / D2038	P2019 / P2017
			53.96	+0.01	8091DB			RSB5400	CW15	WP032	2		
			53.97	+0.02	8091DC			RSB5400	CW15	WP032	2		
			54.45	+0.5	8091D050			RSB5450	CW15	WP032	2		
			54.95	+1.0	8091D100			RSB5500	CW15	WP032	2		
			55.95	+2.0	8091D200			RSB5600	CW15	WP032	2		
YZ125	02-04	125	53.94	Std.	8072DA	-	28	RSB5400	CW15	WP032	2	D2038	P2017
			53.95	+0.01	8072DB			RSB5400	CW15	WP032	2		
			53.96	+0.02	8072DC			RSB5400	CW15	WP032	2		
			55.94	+2.0	8072D200			RSB5600	CW15	WP032	2		



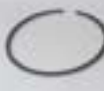

## YAMAHA 2-stroke



					set includes							extra parts		
														
Model	Years	Displ. (cc)	Piston Size (mm)	Over-sizes (mm)	Piston Kit Part No.	Dome Volume (cm <sup>3</sup> )	Comp. Height (mm)	Ring Set Part No.	Clip Part No.	Pin Part No.	Price-code	Top End Gasket Kit	Wössner Connecting Rods	
YZ125	05-09	125	53.95	Std.	8160DA	-	28	RSB5400	CW15	WP032	2	D2039	P2018	
			53.96	+0.01	8160DB			RSB5400	CW15	WP032	2			
			53.97	+0.02	8160DC			RSB5400	CW15	WP032	2			
			55.95	+2.0	8160D200			RSB5600	CW15	WP032	2			
			57.95	+4.0	8160D400			RSB5800	CW15	WP032	2			
DT200R	88-91	195	65.94	Std.	8070DA	-	29.90	RDB6600	CW16	WP027	3	-	-	
			66.34	+0.4	8070D040			RDB6640	CW16	WP027	3			
			65.44	+0.50	8070D050			RDB6650	CW16	WP027	3			
			66.74	+0.8	8070D080			RDB6675	CW16	WP027	3			
			66.94	+1.0	8070D100			RDB6700	CW16	WP027	3			
			67.44	+1.5	8070D150			RDB6750	CW16	WP027	3			
			67.94	+2.0	8070D200			RDB6800	CW16	WP027	3			
			68.44	+2.5	8070D250			RDB6850	CW16	WP027	3			
			68.94	+3.0	8070D300			RDB6900	CW16	WP027	3			
			71.94	+6.0	8070D600			RDB7200	CW16	WP027	3			
			72.44	+6.5	8070D650			RDB7250	CW16	WP027	3			
			72.94	+7.0	8070D700			RDB7300	CW16	WP027	3			
			73.94	+8.0	8070D800			RDB7400	CW16	WP027	3			
WR200	92-98	195	66.74	Std.	8070D080	-	29.90	RDB6675	CW16	WP027	3	-	-	
			66.94	+0.20	8070D100			RDB6700	CW16	WP027	3			
			67.44	+0.70	8070D150			RDB6750	CW16	WP027	3			
			67.94	+1.3	8070D200			RDB6800	CW16	WP027	3			
			68.44	+1.8	8070D250			RDB6850	CW16	WP027	3			
			68.94	+2.3	8070D300			RDB6900	CW16	WP027	3			
YZ250	76-79	246	69.94	Std.	8179DA	-	33	RDB7000	CW18	WP033	3/1	-	-	
IT250	78-80		70.44	+0.5	8179D050			RDB7050	CW18	WP033	3/1			
TY250	74-78		70.94	+1.0	8179D100			RDB7100	CW18	WP033	3/1			
MC250	73-75		71.44	+1.5	8179D150			RDB7150	CW18	WP033	3/1			
DT25 2,3	74-79		71.94	+2.0	8179D200			RDB7200	CW18	WP033	3/1			





## YAMAHA 2-stroke



					set includes							extra parts	
													
Model	Years	Displ. (cc)	Piston Size (mm)	Over-sizes (mm)	Piston Kit Part No.	Dome Volume (cm <sup>3</sup> )	Comp. Height (mm)	Ring Set Part No.	Clip Part No.	Pin Part No.	Price-code	Top End Gasket Kit	Wössner Connecting Rods
YZ250 & IT250	80-82	246	69.94	Std.	8180DA	-	33	RDB7000	CW18	WP033	3/1	-	-
			70.19	+0.25	8180D025			RDB7025	CW18	WP033	3/1		
	70.44		+0.5	8180D050	RDB7050			CW18	WP033	3/1			
	70.69		+0.75	8180D075	RDB7075			CW18	WP033	3/1			
	70.94		+1.0	8180D100	RDB7100			CW18	WP033	3/1			
	71.44		+1.5	8180D150	RDB7150			CW18	WP033	3/1			
	71.94		+2.0	8180D200	RDB7200			CW18	WP033	3/1			
YZ250	83-87	246	67.94	Std.	8133DA	-	36	RDB6800	CW18	WP033	3/1	-	P2048
			68.19	+0.25	8133D025			RDB6825	CW18	WP033	3/1		
			68.44	+0.5	8133D050			RDB6850	CW18	WP033	3/1		
			68.69	+0.75	8133D075			RDB6875	CW18	WP033	3/1		
			68.94	+1.0	8133D100			RDB6900	CW18	WP033	3/1		
			69.19	+1.25	8133D125			RDB6925	CW18	WP033	3/1		
			69.44	+1.5	8133D150			RDB6950	CW18	WP033	3/1		
69.94	+2.0	8133D200	RDB7000	CW18	WP033	3/1							
YZ & WR250	88-91	246	67.94	Std.	8134DA	-	36	RDB6800	CW18	WP033	3/1	D2040	P2048
			67.95	+0.01	8134DB			RDB6800	CW18	WP033	3/1		
			68.19	+0.25	8134D025			RDB6825	CW18	WP033	3/1		
			68.44	+0.5	8134D050			RDB6850	CW18	WP033	3/1		
			68.69	+0.75	8134D075			RDB6875	CW18	WP033	3/1		
			68.94	+1.0	8134D100			RDB6900	CW18	WP033	3/1		
			69.19	+1.25	8134D125			RDB6925	CW18	WP033	3/1		
			69.44	+1.5	8134D150			RDB6950	CW18	WP033	3/1		
69.94	+2.0	8134D200	RDB7000	CW18	WP033	3/1							
YZ250 & WR250	92-98	246	67.94	Std.	8023DA	-	36	RDB6800	CW18	WP033	3	D2040	P2029
			67.95	+0.01	8023DB			RDB6800	CW18	WP033	3		
	67.96		+0.02	8023DC	RDB6800			CW18	WP033	3			
	68.44		+0.5	8023D050	RDB6850			CW18	WP033	3			
	68.94		+1.0	8023D100	RDB6900			CW18	WP033	3			
	69.94		+2.0	8023D200	RDB7000			CW18	WP033	3			

## YAMAHA 2-stroke



					set includes							extra parts		
														
Model	Years	Displ. (cc)	Piston Size (mm)	Over-sizes (mm)	Piston Kit Part No.	Dome Volume (cm <sup>3</sup> )	Comp. Height (mm)	Ring Set Part No.	Clip Part No.	Pin Part No.	Price-code	Top End Gasket Kit	Wössner Connecting Rods	
YZ250	99-09	249	66.35	Std.	8216DA	-	38	RDB6640	CW18	WP033	3	D2041	P2028	
			66.36	+0.01	8216DB			RDB6640	CW18	WP033	3			
			66.37	+0.02	8216DC			RDB6640	CW18	WP033	3			
YZ250 Single Ring	99-09	249	66.35	Std.	8217DA	-	38	RSB6640	CW18	WP033	3/1	D2041	P2028	
			66.36	+0.01	8217DB			RSB6640	CW18	WP033	3/1			
			66.37	+0.02	8217DC			RSB6640	CW18	WP033	3/1			
175CT-2	Thru 1977	172	65.94	Std.	8182DA	-	30	RDB6600	CW16	WP027	3/1			
175CT-3	Thru 1977		66.44	+0.5	8182D050			RDB6650	CW16	WP027	3/1			
175DT	79-81		66.94	+1.0	8182D100			RDB6700	CW16	WP027	3/1			
175MX	79-82		67.44	+1.5	8182D150			RDB6750	CW16	WP027	3/1			
DT175	82-10	175	65,94	Std.	8256DA	-	35	RDB6600	CW16	WP027	3/1	-	-	
			66,44	+0.5	8256D050			RDB6650	CW16	WP027	3/1			
			66,94	+1.0	8256D100			RDB6700	CW16	WP027	3/1			
			67,44	+1.5	8256D150			RDB6750	CW16	WP027	3/1			
			67,94	+2.0	8256D200			RDB6800	CW16	WP027	3/1			
YZ & IT175	76-81	172	65.94	Std.	8177DA	-	30	RDB6600	CW16	WP027	3/1	-	-	
			66.44	+0.5	8177D050			RDB6650	CW16	WP027	3/1			
			66.94	+1.0	8177D100			RDB6700	CW16	WP027	3/1			
			67.44	+1.5	8177D150			RDB6750	CW16	WP027	3/1			
			67.94	+2.0	8177D200			RDB6800	CW16	WP027	3/1			
IT200	84-86	195	65.94	Std.	8176DA	-	30	RDB6600	CW16	WP027	3/1	-	-	
			66.44	+0.5	8176D050			RDB6650	CW16	WP027	3/1			
			66.94	+1.0	8176D100			RDB6700	CW16	WP027	3/1			
			67.44	+1.5	8176D150			RDB6750	CW16	WP027	3/1			
			67.94	+2.0	8176D200			RDB6800	CW16	WP027	3/1			
IT250	83	246	67.94	Std.	8175DA	-	35.80	RDB6800	CW18	WP033	3/1	-	-	
			68.44	+0.5	8175D050			RDB6850	CW18	WP033	3/1			
			68.94	+1.0	8175D100			RDB6900	CW18	WP033	3/1			
			69.44	+1.5	8175D150			RDB6950	CW18	WP033	3/1			
			69.94	+2.0	8175D200			RDB7000	CW18	WP033	3/1			

## YAMAHA 2-stroke







					set includes							extra parts	
Model	Years	Displ. (cc)	Piston Size (mm)	Over-sizes (mm)	Piston Kit Part No.	Dome Volume (cm <sup>3</sup> )	Comp. Height (mm)	Ring Set Part No.	Clip Part No.	Pin Part No.	Price-code	Top End Gasket Kit	Wössner Connecting Rods
RD400 & RD350	76-82 73-90	350	63.94	Std.	8075DA	-	36	RDB6400	CW16	WPO27	8	-	-
			63.95	+0.01	8075DB			RDB6400	CW16	WPO27	8		
			63.96	+0.02	8075DC			RDB6400	CW16	WPO27	8		
			64.19	+0.25	8075D025			RDB6425	CW16	WPO27	8		
			64.44	+0.5	8075D050			RDB6450	CW16	WPO27	8		
			64.69	+0.75	8075D075			RDB6475	CW16	WPO27	8		
			64.94	+1.0	8075D100			RDB6500	CW16	WPO27	8		
			65.19	+1.25	8075D125			RDB6525	CW16	WPO27	8		
			65.44	+1.5	8075D150			RDB6550	CW16	WPO27	8		
			65.94	+2.0	8075D200			RDB6600	CW16	WPO27	8		
66.44	+2.5	8075D250	RDB6650	CW16	WPO27	8							
350 R5	-	350	63.93	Std.	8221DA	-	36	RDB6400	CW16	WPO27	8/1	-	-
			64.18	+0.25	8221D025			RDB6425	CW16	WPO27	8/1		
			64.43	+0.5	8221D050			RDB6450	CW16	WPO27	8/1		
			64.68	+0.75	8221D075			RDB6475	CW16	WPO27	8/1		
			64.93	+1.0	8221D100			RDB6500	CW16	WPO27	8/1		
			65.18	+1.25	8221D125			RDB6525	CW16	WPO27	8/1		
			65.43	+1.5	8221D150			RDB6550	CW16	WPO27	8/1		
			65.93	+2.0	8221D200			RDB6600	CW16	WPO27	8/1		



## YAMAHA-ATV 2-stroke



					set includes							extra parts	
													
Model	Years	Displ. (cc)	Piston Size (mm)	Over-sizes (mm)	Piston Kit Part No.	Dome Volume (cm <sup>3</sup> )	Comp. Height (mm)	Ring Set Part No.	Clip Part No.	Pin Part No.	Price-code	Top End Gasket Kit	Wössner Connecting Rods
YFS200 Blaster	88-09	199	65.94	Std.	8101DA	-	29.90	RDB6600	CW16	WP027	8	-	P2030
			66.19	+0.25	8101D025			RDB6625	CW16	WP027	8		
			66.44	+0.5	8101D050			RDB6650	CW16	WP027	8		
			66.69	+0.75	8101D075			RDB6675	CW16	WP027	8		
			66.94	+1.0	8101D100			RDB6700	CW16	WP027	8		
			67.44	+1.5	8101D150			RDB6750	CW16	WP027	8		
			67.94	+2.0	8101D200			RDB6800	CW16	WP027	8		
TriZ250	85-89	246	67.94	Std.	8175DA	-	35.80	RDB6800	CW18	WP033	3/1	-	-
			68.44	+0.5	8175D050			RDB6850	CW18	WP033	3/1		
			68.94	+1.0	8175D100			RDB6900	CW18	WP033	3/1		
			69.44	+1.5	8175D150			RDB6950	CW18	WP033	3/1		
			69.94	+2.0	8175D200			RDB7000	CW18	WP033	3/1		
YFZ350 Banshee	Thru 2006	347	63.94	Std.	8075DA	-	36	RDB6400	CW16	WP027	8	-	P2035
			63.95	+0.01	8075DB			RDB6400	CW16	WP027	8		
			63.96	+0.02	8075DC			RDB6400	CW16	WP027	8		
			64.19	+0.25	8075D025			RDB6425	CW16	WP027	8		
			64.44	+0.5	8075D050			RDB6450	CW16	WP027	8		
			64.69	+0.75	8075D075			RDB6475	CW16	WP027	8		
			64.94	+1.0	8075D100			RDB6500	CW16	WP027	8		
			65.19	+1.25	8075D125			RDB6525	CW16	WP027	8		
			65.44	+1.5	8075D150			RDB6550	CW16	WP027	8		
65.94	+2.0	8075D200	RDB6600	CW16	WP027	8							
66.44	+2.5	8075D250	RDB6650	CW16	WP027	8							
YFZ350 Banshee Long Rod Kit (+5mm) must use Long rod crank	Thru 2006	347	63.94	Std.	8251DA	-	-	RDB6400	CW16	WP027	8	-	P2049
			64.44	+0.5	8251D050			RDB6450	CW16	WP027	8		
			64.94	+1.0	8251D100			RDB6500	CW16	WP027	8		
			65.44	+1.5	8251D150			RDB6550	CW16	WP027	8		
			65.94	+2.0	8251D200			RDB6600	CW16	WP027	8		
YFZ350 Banshee Long Rod Stroker Kit must use Long rod crank Stroke: 58mm	Thru 2006	373	63.94	Std.	8252DA	-	-	RDB6400	CW16	WP027	8	-	-
			64.44	+0.5	8252D050			RDB6450	CW16	WP027	8		
			64.94	+1.0	8252D100			RDB6500	CW16	WP027	8		
			65.44	+1.5	8252D150			RDB6550	CW16	WP027	8		
			65.94	+2.0	8252D200			RDB6600	CW16	WP027	8		







## YAMAHA 4-stroke



					set includes							extra parts	
													
Model	Years	Displ. (cc)	Piston Size (mm)	Over-sizes (mm)	Piston Kit Part No.	Dome Volume (cm <sup>3</sup> )	Comp. Height (mm)	Ring Set Part No.	Clip Part No.	Pin Part No.	Price-code	Top End Gasket Kit	Wössner Connecting Rods
XT125	all	124	59.95	Std.	8553DA	-	24	600XGS	CW15	WP011	4/1	-	-
			64.95	+5.0	8553D500			650XGS	CW15	WP011	4/1		
TTR125	00-09	124	53.94	Std.	8649DA	+4.1	20.20	540XKS	CW15	WP011	4/1	-	-
			54.44	+0.5	8649D050			545XKS	CW15	WP011	4/1		
			54.94	+1.0	8649D100			550XKS	CW15	WP011	4/1		
YZ250F & WR250F Pro Series 2.Ring 13.8:1	01-04	249	76.96	Std.	8572DA	-4.2	22.20	770XAS-3	CW16	WP059	5	D4029	P4006 / P4005
			76.97	+0.01	8572DB			770XAS-3	CW16	WP059	5		
			76.98	+0.02	8572DC			770XAS-3	CW16	WP059	5		
			78.96	+2.0	8572D200			790XMS	CW16	WP059	5		
			79.96	+3.0	8572D300			800XDS-3	CW16	WP059	5		
82.96	+6.0	8572D600	830XSY	CW16	WP059	5							
YZ250F & WR250F Std-Compr. 3.Ring	01-04	249	76.96	Std.	8559DA	-4.7	22.20	770XAS-3	CW16	WP059	5	D4029	P4006 / P4005
			76.97	+0.01	8559DB			770XAS-3	CW16	WP059	5		
			76.98	+0.02	8559DC			770XAS-3	CW16	WP059	5		
			78.96	+2.0	8559D200			790XMS	CW16	WP059	5		
YZ250F & WR250F Pro Series 2.Ring 13.5:1	05-07	249	76.96	Std.	8612DA	-2.8	22.20	770XAS-3	CW16	WP059	5/1	D4029	P4005
			76.97	+0.01	8612DB			770XAS-3	CW16	WP059	5/1		
			76.98	+0.02	8612DC			770XAS-3	CW16	WP059	5/1		
			79.96	+3.0	8612D300			800XDS-3	CW16	WP059	5/1		
YZ250F & WR250F Std-Compr. 3.Ring	05-07	249	76.96	Std.	8614DA	-4.5	22.20	770XAS-3	CW16	WP059	5	D4029	P4005
			76.97	+0.01	8614DB			770XAS-3	CW16	WP059	5		
			76.98	+0.02	8614DC			770XAS-3	CW16	WP059	5		
			78.96	+2.0	8614D200			790XMS	CW16	WP059	5		
YZ250F & WR250F Std-Compr. 3.Ring 13.5:1	08-10	249	76.96	Std.	8712DA	-2.9	22.20	770XAS-3	CW16	WP059	5	D4029	P4005
			76.97	+0.01	8712DB			770XAS-3	CW16	WP059	5		
			76.98	+0.02	8712DC			770XAS-3	CW16	WP059	5		
YZ250F & WR250F Pro Series 2.Ring 13.8:1	08-10	249	76.96	Std.	8713DA	-2.4	22.20	770XAS-2	CW16	WP059	5	D4029	P4005
			76.97	+0.01	8713DB			770XAS-2	CW16	WP059	5		
			76.98	+0.02	8713DC			770XAS-2	CW16	WP059	5		
			79.96	+3.0	8713D300			800XDS-3	CW16	WP059	5		

## YAMAHA 4-stroke



					set includes							extra parts	
													
Model	Years	Displ. (cc)	Piston Size (mm)	Over-sizes (mm)	Piston Kit Part No.	Dome Volume (cm <sup>3</sup> )	Comp. Height (mm)	Ring Set Part No.	Clip Part No.	Pin Part No.	Price-code	Top End Gasket Kit	Wössner Connecting Rods
TTR250	96-09	249	72.95	Std.	8646DA	-	23.60	730XDS	CW18	WP031	5/1	-	-
			73.45	+0.5	8646D050			735XDS	CW18	WP031	5/1		
			73.95	+1.0	8646D100			740XDS	CW18	WP031	5/1		
			74.45	+1.5	8646D150			745XDS	CW18	WP031	5/1		
			74.95	+2.0	8646D200			750XDS	CW18	WP031	5/1		
WR250X 11.8:1	08-09	249	76.96	Std.	8729DA	-5.85	22.90	770XAS-3	CW17	WP083	5/1	-	-
			76.97	+0.01	8729DB			770XAS-3	CW17	WP083	5/1		
			76.98	+0.02	8729DC			770XAS-3	CW17	WP083	5/1		
WR250X Pro Series 13.5:1	08-09	249	76.96	Std.	8772DA	-	22.90	770XAS-3	CW17	WP083	5	-	-
			76.97	+0.01	8772DB			770XAS-3	CW17	WP083	5		
			76.98	+0.02	8772DC			770XAS-3	CW17	WP083	5		
TT & XT350	85-96	346	85.94	Std.	8502DA	-	25	860XSY-3	CW19	WP050	7	-	-
			86.44	+0.5	8502D050			865XSY-3	CW19	WP050	7		
			86.94	+1.0	8502D100			870XSY-3	CW19	WP050	7		
			87.44	+1.5	8502D150			875XSY-3	CW19	WP050	7		
			87.94	+2.0	8502D200			880XSY-3	CW19	WP050	7		
			88.44	+2.5	8502D250			885XSY-3	CW19	WP050	7		
YZ400F & WR400F 12.5:1	98-00	399	91.95	Std.	8603DA	+8.4	24.50	920XSY	CW18	WP053	7	-	-
			91.96	+0.01	8603DB			920XSY	CW18	WP053	7		
			91.97	+0.02	8603DC			920XSY	CW18	WP053	7		
			92.95	+1.0	8603D100			930XSY	CW18	WP053	7		
			93.95	+2.0	8603D200			940XSY	CW18	WP053	7		
YZ400F & WR400F Pro Series 13.5:1	98-00	399	91.95	Std.	8639DA	-	24.10	920XSY	CW18	WP053	7	-	-
			91.96	+0.01	8639DB			920XSY	CW18	WP053	7		
			91.97	+0.02	8639DC			920XSY	CW18	WP053	7		
			92.95	+1.0	8639D100			930XSY	CW18	WP053	7		
			93.95	+2.0	8639D200			940XSY	CW18	WP053	7		
YZ426F & WR426F	00-02	426	94.96	Std.	8525DA	-7	24.10	950XDS	CW19	WP037	7/1	-	-
			94.97	+0.01	8525DB			950XDS	CW19	WP037	7/1		
			94.98	+0.02	8525DC			950XDS	CW19	WP037	7/1		
			96.96	+2.0	8525D200			970XDS	CW19	WP037	7/1		
			97.96	+3.0	8525D300			980XDS	CW19	WP037	7/1		

## YAMAHA 4-stroke



Model	Years	Displ. (cc)	Piston Size (mm)	Over-sizes (mm)	Piston Kit Part No.	Dome Volume (cm <sup>3</sup> )	Comp. Height (mm)	set includes				extra parts	
								Ring Set Part No.	Clip Part No.	Pin Part No.	Price-code	Top End Gasket Kit	Wössner Connecting Rods
YZ426F & WR426F Pro Series	00-02	426	94.96	Std.	8640DA	-5.75	24.10	950ADS-2	CW19	WP037	7/1	-	-
			94.97	+0.01	8640DB			950ADS-2	CW19	WP037	7/1		
			94.98	+0.02	8640DC			950ADS-2	CW19	WP037	7/1		
			96.96	+2.0	8640D200			970ADS-2	CW19	WP037	7/1		
YZ450F & WR450F	03-04	449	94.96	Std.	8562DA	-9.85	23.50	950ADS-2	CW18	WP053	7	D4030	P4007
			94.97	+0.01	8562DB			950ADS-2	CW18	WP053	7		
			94.98	+0.02	8562DC			950ADS-2	CW18	WP053	7		
			96.96	+2.0	8562D200			970ADS-2	CW18	WP053	7		
			97.96	+3.0	8562D300			980ADS-2	CW18	WP053	7		
YZ450F & WR450F Pro Series	03-04	449	94.96	Std.	8570DA	-	23.50	950ADS-2	CW18	WP053	7/1	D4030	P4007
			94.97	+0.01	8570DB			950ADS-2	CW18	WP053	7/1		
			94.98	+0.02	8570DC			950ADS-2	CW18	WP053	7/1		
YZ450F & WR450F 12.3:1	05	449	94.95	Std.	8613DA	-10.3	23.50	950ADS-2	CW18	WP053	7/1	D4030	P4007
			94.96	+0.01	8613DB			950ADS-2	CW18	WP053	7/1		
			94.97	+0.02	8613DC			950ADS-2	CW18	WP053	7/1		
YZ450F & WR450F Pro Series 13.5:1	05	449	94.95	Std.	8647DA	-6.3	23.50	950ADS-2	CW18	WP053	7/1	D4030	P4007
			94.96	+0.01	8647DB			950ADS-2	CW18	WP053	7/1		
			94.97	+0.02	8647DC			950ADS-2	CW18	WP053	7/1		
YZ450F & WR450F 12.3:1	06-09	449	94.96	Std.	8630DA	-9.7	23.50	950ADS-2	CW18	WP053	7	D4031	P4008
			94.97	+0.01	8630DB			950ADS-2	CW18	WP053	7		
			94.98	+0.02	8630DC			950ADS-2	CW18	WP053	7		
YZ450F & WR450F Pro Series 13.5:1	06-09	449	94.96	Std.	8631DA	-6.1	23.50	950ADS-2	CW18	WP053	7	D4031	P4008
			94.97	+0.01	8631DB			950ADS-2	CW18	WP053	7		
			94.98	+0.02	8631DC			950ADS-2	CW18	WP053	7		
YZ450F	10	449.7	96.96	Std.	8776DA	-5.4	24	970ADS-2	CW18	WP072	7	-	P4032
			96.97	+0.01	8776DB			970ADS-2	CW18	WP072	7		
			96.98	+0.02	8776DC			970ADS-2	CW18	WP072	7		
YZ450F HC	10	449.7	96.96	Std.	8783DA	-2.1	24	970ADS-2	CW18	WP072	7	-	P4032
			96.97	+0.01	8783DB			970ADS-2	CW18	WP072	7		
			96.98	+0.02	8783DC			970ADS-2	CW18	WP072	7		

## YAMAHA 4-stroke



Model	Years	Displ. (cc)	Piston Size (mm)	Over-sizes (mm)	Piston Kit Part No.	Dome Volume (cm <sup>3</sup> )	Comp. Height (mm)	set includes				extra parts	
								Ring Set Part No.	Clip Part No.	Pin Part No.	Price-code	Top End Gasket Kit	Wössner Connecting Rods
XT500 & TT & SR	all	449	86.93	Std.	8505DA	-	29	870XSY-3	CW20	WP052	7/1	-	-
			87.43	+0.5	8505D050			875XSY-3	CW20	WP052	7/1		
			87.93	+1.0	8505D100			880XSY	CW20	WP052	7/1		
			88.43	+1.5	8505D150			885XSY	CW20	WP052	7/1		
			88.93	+2.0	8505D200			890XSY-3	CW20	WP052	7/1		
			89.93	+3.0	8505D300			900XSY	CW20	WP052	7/1		
XT600 & XT600E & TT600 & JT600R	84-03	600	94.93	Std.	8501DA	-0.5	28	950XSY-3	CW22	WP009	7	-	-
			94.94	+0.01	8501DB			950XSY-3	CW22	WP009	7		
			94.95	+0.02	8501DC			950XSY-3	CW22	WP009	7		
			95.43	+0.5	8501D050			955XSY	CW22	WP009	7		
			95.93	+1.0	8501D100			960XSY-3	CW22	WP009	7		
			96.43	+1.5	8501D150			965XSY	CW22	WP909	7		
			96.93	+2.0	8501D200			970XSY	CW22	WP009	7		
			97.43	+2.5	8501D250			975XSY-3	CW22	WP909	7		
			97.93	+3.0	8501D300			980XSY-3	CW22	WP009	7		
			98.93	+4.0	8501D400			990XSY-3	CW22	WP009	7		
			99.93	+5.0	8501D500			1000XSY-3	CW22	WP009	7		
			100.93	+6.0	8501D600			1010XSY-3	CW22	WP009	7		
101.93	+7.0	8501D700	1020XSU-3	CW22	WP009	7							
XTZ660 Tenere	91-98	660	99.93	Std.	8507DA	-0.3	27	1000XSY-3	CW22	WP017	7/1	-	-
			99.94	+0.01	8507DB			1000XSY-3	CW22	WP017	7/1		
			99.95	+0.02	8507DC			1000XSY-3	CW22	WP017	7/1		
			100.93	+1.0	8507D100			1010XSY-3	CW22	WP017	7/1		
			101.53	+1.6	8507D160			1016XSU	CW22	WP017	7/1		
			101.93	+2.0	8507D200			1020XSU-3	CW22	WP017	7/1		
XT660R	04-09	660	99.95	Std.	8617DA	-	27.50	1000XSY	CW23	WP024	7/1	-	-
			99.96	+0.01	8617DB			1000XSY	CW23	WP024	7/1		
			99.97	+0.02	8617DC			1000XSY	CW23	WP024	7/1		





## YAMAHA-ATV 4-stroke



Model	Years	Displ. (cc)	Piston Size (mm)	Over-sizes (mm)	Piston Kit Part No.	Dome Volume (cm <sup>3</sup> )	Comp. Height (mm)	set includes				extra parts	
								Ring Set Part No.	Clip Part No.	Pin Part No.	Price-code	Top End Gasket Kit	Wössner Connecting Rods
YFM250 Timberwolf & YFB250 Bear Tracker	01-02	229.6	70.94	Std.	8659DA	-4.7	22.20	710XDS	CW16	WP041	5/1	-	-
			71.44	+0.5	8659D050			715XDS	CW16	WP041	5/1		
			71.94	+1.0	8659D100			720XDS	CW16	WP041	5/1		
			72.44	+1.5	8659D150			725XDS	CW16	WP041	5/1		
			72.94	+2.0	8659D200			730XDS	CW16	WP041	5/1		
YFM 250R Raptor & YBR250	08-10	-	73.95	Std.	8724DA	+2.37	23.50	740XDS-3	CW17	WP083	5	-	P4035
			73.96	+0.01	8724DB	+2.37		740XDS-3	CW17	WP083	5		
			73.97	+0.02	8724DC	+2.37		740XDS	CW17	WP083	5		
			75.95	+2.0	8724D200	+1.1		760XDS-3	CW17	WP083	5		
			80.95	+7.0	8724D700	-2.1		81XDS-3	CW17	WP083	5		
YFM350 Warrior & Big Bear	86-05	349	82.94	Std.	8605DA	-	28.30	830XSY	CW19	WP026	5/1	-	P4034
			82.95	+0.01	8605DB			830XSY	CW19	WP026	5/1		
			83.44	+0.5	8605D050			835XSY-3	CW19	WP026	5/1		
			83.94	+1.0	8605D100			840XSY	CW19	WP026	5/1		
YFZ450 Std. comp.	04-05	449	94.95	Std.	8601DA	-7.36	25	950XSY-3	CW20	WP038	7	D4032	P4029
			94.96	+0.01	8601DB			950XSY-3	CW20	WP038	7		
			94.97	+0.02	8601DC			950XSY-3	CW20	WP038	7		
			97.95	+3.0	8601D300			980XSY	CW20	WP038	7		
YFZ450 Pro-Series 13.5:1	04-05	449	94.95	Std.	8655DA	-2.8	25	950ADS-2	CW20	WP038	7/1	D4032	P4029
			94.96	+0.01	8655DB			950ADS-2	CW20	WP038	7/1		
			94.97	+0.02	8655DC			950ADS-2	CW20	WP038	7/1		
YFZ450 ATV 11.4:1	06-09	449	94.95	Std.	8784DA	-8.5	25.10	950XDS	CW20	WP029	7	-	-
			94.96	+0.01	8784DB			950XDS	CW20	WP029	7		
			94.97	+0.02	8784DC			950XDS	CW20	WP029	7		
YFZ450 Pro-Series 13.5:1	06-09	449	94.95	Std.	8657DA	-1.6	25.10	950ADS-2	CW20	WP038	7	D4032	P4030
			94.96	+0.01	8657DB			950ADS-2	CW20	WP038	7		
			94.97	+0.02	8657DC			950ADS-2	CW20	WP038	7		





## YAMAHA-ATV 4-stroke



					set includes							extra parts	
													
Model	Years	Displ. (cc)	Piston Size (mm)	Over-sizes (mm)	Piston Kit Part No.	Dome Volume (cm <sup>3</sup> )	Comp. Height (mm)	Ring Set Part No.	Clip Part No.	Pin Part No.	Price-code	Top End Gasket Kit	Wössner Connecting Rods
YFM600 Grizzly	98-02	600	94.93	Std.	8501DA	-0.5	28	950XSY-3	CW22	WP009	7	-	-
			94.94	+0.01	8501DB			950XSY-3	CW22	WP009	7		
			94.95	+0.02	8501DC			950XSY-3	CW22	WP009	7		
			95.43	+0.5	8501D050			955XSY	CW22	WP009	7		
			95.93	+1.0	8501D100			960XSY-3	CW22	WP009	7		
			96.43	+1.5	8501D150			965XSY	CW22	WP009	7		
			96.93	+2.0	8501D200			970XSY	CW22	WP009	7		
			97.43	+2.5	8501D250			975XSY-3	CW22	WP009	7		
			97.93	+3.0	8501D300			980XSY-3	CW22	WP009	7		
			98.93	+4.0	8501D400			990XSY-3	CW22	WP009	7		
			99.93	+5.0	8501D500			1000XSY-3	CW22	WP017	7		
100.93	+6.0	8501D600	1010XSY-3	CW22	WP017	7							
101.93	+7.0	8501D700	1020XSU-3	CW22	WP017	7							
YFM660R Raptor & YFM660F Grizzly	01-09	660	99.93	Std.	8507DA	-0.3	27	1000XSY-3	CW22	WP017	7/1	-	P4037 / P4038
			99.94	+0.01	8507DB			1000XSY-3	CW22	WP017	7/1		
			99.95	+0.02	8507DC			1000XSY-3	CW22	WP017	7/1		
			100.93	+1.0	8507D100			1010XSY-3	CW22	WP017	7/1		
			101.93	+2.0	8507D200			1020XSU-3	CW22	WP017	7/1		
YFM660R Raptor & YFM660F Grizzly Hi-Compr.	01-09	660	99.93	Std.	8577DA	-	27	1000XSY	CW22	WP009	7/1	-	P4037 / P4038
			99.94	+0.01	8577DB			1000XSY	CW22	WP009	7/1		
			99.95	+0.02	8577DC			1000XSY	CW22	WP009	7/1		
			101.93	+2.0	8577D200			1020XSU	CW22	WP009	7/1		
YFM700 Raptor Pro-Series 11:1	06-09	686	101.94	Std.	8673DA	-	27.50	1020XSU-3	CW23	WP024	7/1	-	P4031
			102.94	+1.0	8673D100			1030XSU	CW23	WP024	7/1		
			103.94	+2.0	8673D200			1040XSU	CW23	WP024	7/1		





## APRILIA 2-stroke



					set includes							extra parts	
													
Model	Years	Displ. (cc)	Piston Size (mm)	Over-sizes (mm)	Piston Kit Part No.	Dome Volume (cm <sup>3</sup> )	Comp. Height (mm)	Ring Set Part No.	Clip Part No.	Pin Part No.	Price-code	Top End Gasket Kit	Wössner Connecting Rods
Futura, AF1, RX, Red Rose, Rally, Syntesi, Pegaso, Tuareg, Europe, Replica, RS125	85-09	125	53.95	Std.	8027DA	-	29	RDB5400	CW15	WP032	2		
			53.96	+0.01	8027DB			RDB5400	CW15	WP032	2		
			53.97	+0.02	8027DC			RDB5400	CW15	WP032	2		
			53.98	+0.03	8027DD			RDB5400	CW15	WP032	2		
			53.99	+0.04	8027DE			RDB5400	CW15	WP032	2		
			54.20	+0.25	8027D025			RDB5425	CW15	WP032	2		
			54.45	+0.5	8027D050			RDB5450	CW15	WP032	2		
			54.70	+0.75	8027D075			RDB5475	CW15	WP032	2		
54.95	+1.0	8027D100	RDB5500	CW15	WP032	2							
RS125 1Ring	-	-	53.95	Std.	8253DA	-	29	RSB5400	CW15	WP032	2		
			53.96	+0.01	8253DB			RSB5400	CW15	WP032	2		
			53.97	+0.02	8253DC			RSB5400	CW15	WP032	2		
GP125	-	125	53.965	Std.	8243DA	-	24	RSA5400	CW15	WP032	21		
			53.97	+0.005	8243D005			RSA5400	CW15	WP032	21		
			53.975	+0.010	8243D010			RAS5400	CW15	WP032	21		
			53.98	+0.015	8243D015			RSA5400	CW15	WP032	21		
			53.985	+0.020	8243D020			RSA5400	CW15	WP032	21		
			53.99	+0.025	8243D025			RSA5400	CW15	WP032	21		
54.00	+0.035	8243D035	RSA5400	CW15	WP032	21							
RS250, Bicilindrico Twin Single Ring	all	349	55.95	Std.	8039DA	-	28.50	RSB5600	CW16	WP036	3		
			55.96	+0.01	8039DB			RSB5600	CW16	WP036	3		
			55.97	+0.02	8039DC			RSB5600	CW16	WP036	3		
			56.45	+0.5	8039D050			RSB5650	CW16	WP036	3		
			56.95	+1.0	8039D100			RSB5700	CW16	WP036	3		

## APRILIA SCOOTER 4-stroke



					set includes							extra parts		
														
Model	Years	Displ. (cc)	Piston Size (mm)	Over-sizes (mm)	Piston Kit Part No.	Dome Volume (cm <sup>3</sup> )	Comp. Height (mm)	Ring Set Part No.	Clip Part No.	Pin Part No.	Price-code	Top End Gasket Kit	Wössner Connecting Rods	
Atlantic, Scarabeo	04-05	250	71.96	Std.	8744DA	-10.8	23.50	720XDS	CW15	WP032	22	-	-	
			72.21	+0.25	8744D025			725XDS	CW15	WP032	22			
			72.46	+0.5	8744D050			725XDS	CW15	WP032	22			
			72.71	+0.75	8744D075			730XDS	CW15	WP032	22			
Leonardo	-	300	70.96	Std.	8745DA	-	-	710XDS	-	-	23	-	-	
			70.97	+0.01	8745DB			710XDS	-	-	23			





## BMW 4-stroke

### The new light weight kit

For BMW • 1200 • 1150 • 1100

The reduction in weight of about 200 gr per unit results from 3 mm longer conrods in connection with 3 mm shortened pistons.





					set includes							extra parts	
Model	Years	Displ. (cc)	Piston Size (mm)	Over-sizes (mm)	Piston Kit Part No.	Dome Volume (cm <sup>3</sup> )	Comp. Height (mm)	Ring Set Part No.	Clip Part No.	Pin Part No.	Price-code	Top End Gasket Kit	Wössner Connecting Rods
1100/1150 RS, GS, S	all	1085	98.96	Std.	K8543DA-2	+2.3	32.10	990XSY	OEM	WP069	9	-	-
1100/1150 RS, GS, S	all	1129	100.96	+2.0	K8543D200-2	+2.3	32.10	1010XSY-3	OEM	WP069	9	-	-
1100/1150 RS, GS, RT, R Longer con rod *	all	1170	100.96	Std.	K8711D200-2	+4.4	29	1010XSY-3	OEM	WP009	9	-	PM001-2
1200 ST, C Cruiser Welle	all	1170	100.96	Std.	K8544DA-2	+2.4	30.70	1010XSY-3	OEM	WP069	9	-	-
R1200 GS, S, ST, RT, R	06-09	1170	100.96	Std.	K8658DA-2	-	30.90	1010XSY-3	OEM	WP069	9	-	-
R1200 GS, S, ST, RT, R Pro Series 12.7:1	06-09	1170	100.96	Std.	K8695DA-2	+4.4	30.90	1010XSY-3	OEM	WP069	9	-	-
R1200 GS, S, ST, RT, R Pro Series 12.7:1 Longer con rod *	06-09	1170	100.96	Std.	K8710DA-2	+4.4	27.90	1010XSY-3	OEM	WP069	9	-	PM001
R1200 GS, RT, R	10	1170	100.96	Std.	K8788DA-2	-2.4	31	1010XSY-3	OEM	WP069	9	-	-
R1200 GS, RT, R Longer con rod *	10	1170	100.96	Std.	K8789DA-2	-2.4	28	1010XSY-3	OEM	WP069	9	-	PM001

Description *	Article Number	G / Pin Diameter	Big End Width	Small End Width	Between Centres	Weight w/o bolts	Price Code
1200 GS, S, ST, RT, R	PM001	22mm	24.50mm	21.90mm	128mm	439gr.	21
1100/1150 RS, GS, S	PM001-2	22mm	21.90mm	21.90mm	128mm	405gr.	21

## CAGIVA 2-stroke

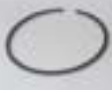

					set includes							extra parts		
														
Model	Years	Displ. (cc)	Piston Size (mm)	Over-sizes (mm)	Piston Kit Part No.	Dome Volume (cm <sup>3</sup> )	Comp. Height (mm)	Ring Set Part No.	Clip Part No.	Pin Part No.	Price-code	Top End Gasket Kit	Wössner Connecting Rods	
Mito, domed	till 92 & 99-09	124	55.95	Std.	8018DA	-	25	RDB5600	CW16	WP036	2	-	-	
			55.96	+0.01	8018DB			RDB5600	CW16	WP036	2			
			55.97	+0.02	8018DC			RDB5600	CW16	WP036	2			
			56.45	+0.5	8018D050			RDB5650	CW16	WP036	2			
			56.95	+1.0	8018D100			RDB5700	CW16	WP036	2			
Mito, Flat top	93-98	124	55.95	Std.	8053DA	-	25	RDB5600	CW16	WP036	2	-	-	
			55.96	+0.01	8053DB			RDB5600	CW16	WP036	2			
			55.97	+0.02	8053DC			RDB5600	CW16	WP036	2			
			56.45	+0.5	8053D050			RDB5650	CW16	WP036	2			
			56.95	+1.0	8053D100			RDB5700	CW16	WP036	2			



## DUCATI 4-stroke



					set includes							extra parts	
													
Model	Years	Displ. (cc)	Piston Size (mm)	Over-sizes (mm)	Piston Kit Part No.	Dome Volume (cm <sup>3</sup> )	Comp. Height (mm)	Ring Set Part No.	Clip Part No.	Pin Part No.	Price-code	Top End Gasket Kit	Wössner Connecting Rods
848 Racing	07-08	848	93.94	Std.	8765DA	-	-	940XSY	-	-	24/1	-	-
900SS, Monster 13.5:1	all	904	91.94	Std.	K8545DA	-	28.60	920XSY	CW19	WP018	7/1	-	-
			93.94	+2.0	K8545D200			940XSY	CW19	WP018	7/1		
			94.94	+3.0	K8545D300			950XSY	CW19	WP018	7/1		
			95.94	+4.0	K8545D400			960XSY	CW19	WP018	7/1		
996RS, Monster S4R	all	998	97.94	Std.	K8756DA	-	-	980XSY	-	-	24/1	-	-
996 SPS	all	998	97.94	Std.	8757DA	-	-	980XSY	-	-	24/1	-	-
998 Testa Stretta Racing	all	-	99.94	Std.	8758DA	-	-	1000XSY	-	-	24/1	-	-
999R Racing	03-04	-	103.94	Std.	8759DA	-	-	1040XSU	-	-	24/1	-	-
999R Racing	05-06	-	103.94	Std.	8760DA	-	-	1040XSU	-	-	24/1	-	-
999F Racing	03-04	-	103.94	Std.	8761DA	-	-	1040XSU	-	-	24/1	-	-
999F Racing	05-06	-	103.94	Std.	8762DA	-	-	1040XSU	-	-	24/1	-	-
1098 Racing	all	-	103.94	Std.	8763DA	-	-	1040XSU	-	-	24/1	-	-
1098RS Racing	all	-	105.94	Std.	8764DA	-	-	1060XSU	-	-	24/1	-	-



## HONDA 2-stroke











					set includes							extra parts		
														
Model	Years	Displ. (cc)	Piston Size (mm)	Over-sizes (mm)	Piston Kit Part No.	Dome Volume (cm <sup>3</sup> )	Comp. Height (mm)	Ring Set Part No.	Clip Part No.	Pin Part No.	Price-code	Top End Gasket Kit	Wössner Connecting Rods	
RS125 GP	92-94	124	53.93	Std.	8162DA	-	30	RSA5400	CW14	WP058	21	-	-	
			53.94	+0.01	8162DB			RSA5400	CW14	WP058	21			
			53.95	+0.02	8162DC			RSA5400	CW14	WP058	21			
			53.96	+0.03	8162DD			RSA5400	CW14	WP058	21			
RS125 GP	95-97	124	53.93	Std.	8242DA	-	-	RSA5400	CW15	WP032	21	-	-	
			53.94	+0.01	8242DB			RSA5400	CW15	WP032	21			
			53.95	+0.02	8242DC			RSA5400	CW15	WP032	21			
			53.96	+0.03	8242DD			RSA5400	CW15	WP032	21			
RS125 GP Domed	03-07	124	53.94	Std.	8244DA	-	29	RSA5400	CW15	WP032	21	-	-	
			53.95	+0.01	8244DB			RSA5400	CW15	WP032	21			
			53.96	+0.02	8244DC			RSA5400	CW15	WP032	21			
RS125 GP Flat	03-07	124	53.94	Std.	8245DA	-	29	RSA5400	CW15	WP032	21	-	-	
			53.95	+0.01	8245DB			RSA5400	CW15	WP032	21			
			53.96	+0.02	8245DC			RSA5400	CW15	WP032	21			



## HONDA 4-stroke



set includes											extra parts																																																																																																																																																																																																																																																																																																																																													
																																																																																																																																																																																																																																																																																																																																																								

## KAWASAKI 2-stroke







					set includes							extra parts	
Model	Years	Displ. (cc)	Piston Size (mm)	Over-sizes (mm)	Piston Kit Part No.	Dome Volume (cm <sup>3</sup> )	Comp. Height (mm)	Ring Set Part No.	Clip Part No.	Pin Part No.	Price-code	Top End Gasket Kit	Wössner Connecting Rods
350 S2 Mach II Triple Cylinder	71	346	52.94	Std.	K8255DA-3	-	28.50	RDB5300	CW15	WP032	29	-	-
			53.44	+0.5	K8255D050-3			RDB5350	CW15	WP032	29		
			53.94	+1.0	K8255D100-3			RDB5400	CW15	WP032	29		
			54.44	+1.5	K8255D150-3			RDB5450	CW15	WP032	29		
500 S & 500 H1 & 500 KH Triple Cylinder	-	-	59.93	Std.	K8247DA-3	-	31.90	RDB6000	CW16	WP041	29	-	-
			60.43	+0.5	K8247D050-3			RDB6050	CW16	WP041	29		
			60.93	+1.0	K8247D100-3			RDB6100	CW16	WP041	29		
			61.43	+1.5	K8247D150-3			RDB6150	CW16	WP041	29		
			61.93	+2.0	K8247D200-3			RDB6200	CW16	WP041	29		
750 Mach IV & 750 H2 Triple Cylinder	-	-	70.93	Std.	K8248DA-3	-	32	RDB7100	CW16	WP027	30	-	-
			71.43	+0.5	K8248D050-3			RDB7150	CW16	WP027	30		
			71.93	+1.0	K8248D100-3			RDB7200	CW16	WP027	30		
			72.43	+1.5	K8248D150-3			RDB7250	CW16	WP027	30		
			72.93	+2.0	K8248D200-3			RDB7300	CW16	WP027	30		
			73.43	+2.5	K8248D250-3			RDB7350	CW16	WP027	30		



Jay Springsteen and Jimmy Felice winner at the Sports Twins Class with Wössner Pistons at Daytona, 2007

## KAWASAKI 4-stroke







					set includes							extra parts	
													
Model	Years	Displ. (cc)	Piston Size (mm)	Over-sizes (mm)	Piston Kit Part No.	Dome Volume (cm <sup>3</sup> )	Comp. Height (mm)	Ring Set Part No.	Clip Part No.	Pin Part No.	Price-code	Top End Gasket Kit	Wössner Connecting Rods
EX650 Ninja 3-Ring 12.6:1	06-08	-	82.95	Std.	K8696DA-2	-	-	OEM *	CW19	WP028	5/1	-	-
EX650 Ninja 2-Ring 12.6:1	06-08	-	82.95	Std.	K8697DA-2	-	-	830XSY	CW19	WP028	5/1	-	-
EX650 Ninja 3-Ring 12.6:1	09	-	83.95	Std.	K8721DA-2	-	23.60	OEM *	CW19	WP028	5/1	-	-
EX650 Ninja 2-Ring 12.6:1	09	-	83.95	Std.	K8726DA-2	-	-	840XSY	CW19	WP028	5/1	-	-
ZX10R Racing 13.5:1	04-07	998	75.94	Std.	K8746DA-4	-1.4	22.70	760XDS	CW17	WP090	10/1	-	-
			77.94	+2.0	K8746D200-4			780XDS	CW17	WP090	10/1		
			78.94	+3.0	K8746D300-4			790XDS	CW17	WP090	10/1		
ZX10R Turbo 10:1	04-07	998	75.94	Std.	K8767DA-4	-9.3	22.70	760XWY	CW17	WP090	10/1	-	-
			77.94	+2.0	K8767D200-4			780XWY	CW17	WP090	10/1		
			78.94	+3.0	K8767D300-4			790XDS-3	CW17	WP090	10/1		
ZX10R	08-10	998	75.95	Std.	K8786DA-4	-	-	760XWY	-	-	10	-	-
			77.95	+2.0	K8786D200-4			780XWY	-	-	10		
ZX10R Turbo	08-10	998	75.94	Std.	K8787DA-4	-	-	-	-	-	10	-	-
		1051	77.95	+2.0	K8787D200-4			-	-	-	-		
KZ1000J, R 17mm Pin	81-83	1075	71.94	+2.5	K8796D250-4	-	-	720XDS	CW17	-	10	-	-
		1105	72.94	+3.5	K8796D350-4			730XDS	CW17	-	10		
KZ1000, ST Z1R, Z2R	thru 80 77-80	1045	70.94	+1.0	K8797D100-4	-	-	710XDS	CW17	-	10	-	-
		1075	71.94	+2.0	K8797D200-4			720XDS	CW17	-	10		
KZ1100, GPZ1100, GPZX1100, ZX1100 18mm Pin	83-84	1170	74.94	+2.5	K8798D250-4	-	-	750XDS	CW18	-	10	-	-
		1262	77.94	-	K8798D550-4			780XDS	CW18	-	10		
ZX11 C1	90-94	1109	77.94	+2.0	K8800D200-4	-	-	780XDS	CW18	-	10	-	-
ZX11 D1	93-01												
ZZR1100	90-01												
ZRX1100	97-01												
GPZ1100	95-97												

all 4 cylinder kits include: (4) pistons, ring sets, piston pins, clips

## KAWASAKI 4-stroke



					set includes							extra parts	
													
Model	Years	Displ. (cc)	Piston Size (mm)	Over-sizes (mm)	Piston Kit Part No.	Dome Volume (cm <sup>3</sup> )	Comp. Height (mm)	Ring Set Part No.	Clip Part No.	Pin Part No.	Price-code	Top End Gasket Kit	Wössner Connecting Rods
ZX11	90-00	1080	76.95	+1.0	K8801D100-4	-	-	770XDS	-	-	10	-	-
		1190	77.95	+2.0	K8801D200-4	-	-	780XDS	-	-	10	-	-
ZX12 Turbo 9.8:1	00-05	1198	82.93	Std.	K8779DA-4	-	-	830XTY	-	-	10/1	-	-
		1257	84.93	+2.0	K8779D200-4	-	-	850XTY	-	-	10/1	-	-
ZX14 HC	06-09	-	83.95	Std.	K8785DA-4	-2.4	24.50	840XDS	CW20	WP038	10/1	-	-
			85.95	+2.0	K8785D200-4			860XDS-3	CW20	WP038	10/1		
ZX14 Turbo	06-09	-	83.93	Std.	K8780DA-4	-18	24.50	840XDS	CW20	WP065	10/1	-	-
			85.93	+2.0	K8780D200-4			860XDS-3	CW20	WP065	10/1		

all 4 cylinder kits include: (4) pistons, ring sets, piston pins, clips





## SUZUKI 4-stroke







Model	Years	Displ. (cc)	Piston Size (mm)	Over-sizes (mm)	Piston Kit Part No.	Dome Volume (cm <sup>3</sup> )	Comp. Height (mm)	set includes				extra parts	
								Ring Set Part No.	Clip Part No.	Pin Part No.	Price-code	Top End Gasket Kit	Wössner Connecting Rods
GSXR1100 & GSF1200 Bandit & GSXR1100F Katana	89-92	1216	79.94	+2.0	K8530D200-4	-	25.30	800XDS	CW20	WP029	10	-	-
			80.94	+3.0	K8530D300-4			810XSY	CW20	WP029	10		
			81.94	+4.0	K8530D400-4			820XSY	CW20	WP029	10		
			82.94	+5.0	K8530D500-4			830XSY	CW20	WP029	10		
			84.94	+7.0	K8530D700-4			850XSY	CW20	WP029	10		
GSXR 1000 14:1	01-04	1000	72.96	Std.	K8754DA-4	-3	22.55	730XDS	CW16	WP059	10	-	PM005
GSXR 1000 Turbo 10:1	01-04	-	72.96	Std.	K8755DA-4	-12.1	22.55	730XDS	CW16	WP059	10	-	PM006
GSXR 1000 14:1	06-08	1000	73.36	Std.	K8700DA-4	-3.9	22.50	735XDS	CW15	WP011	10	-	-
			74.96	+1.6	K8700D160-4			750XDS	CW15	WP011	10		
			75.96	+2.6	K8700D260-4			760XDS	CW15	WP011	10		
GSXR 1000 Turbo 10:1	05-08	1000	73.36	Std.	K8747DA-4	-12.5	22.50	735XDS	CW15	WP011	10	-	-
			74.96	+1.6	K8747D160-4			750XDS	CW15	WP011	10		
			-	+2.6	K8747D260-4			760XDS	CW15	WP011	10		
GSXR1000 09 K9	09	1000	74.46	Std.	K8790DA-4	-	22.35	745XDS-3	CW15	WP011	10	-	-
			76.46	+2.0	K8790D200-4			765XDS-3	CW15	WP011	10		
GSXR1000	09-10	999	74.46	Std.	K8794DA-4	-	22.35	-	CW15	-	10	-	-
Hayabusa	99-07	244	80.95	Std.	K8730DA-4	-3.3	25.10	810XDS-3	CW20	WP029	10	-	PM002
			83.95	+3.0	K8730D300-4			840XDS	CW20	WP029	10		
Hayabusa Turbo 9:1	99-07	-	80.93	Std.	K8734DA-4	-17.5	26.80	810XDS-3	CW20	WP065	10	-	PM002
			82.93	+2.0	K8734D200-4			830XDS-3	CW20	WP065	10		
Hayabusa 13.5:1	08-09	-	80.95	Std.	K8733DA-4	-4.2	24	810XDS-3	CW18	WP054	10	-	PM003
			82.95	+3.0	K8733D200-4			830XDS-3	CW18	WP054	10		
			83.95	+4.0	K8733D300-4			840XDS-3	CW18	WP054	10		
Hayabusa Turbo 9:1	08-09	-	80.93	Std.	K8736DA-4	-19.3	24	810XDS-3	CW18	WP064	10	-	PM003
			82.93	+2.0	K8736D200-4			830XDS-3	CW18	WP064	10		

all 4 cylinder kits include: (4) pistons, ring sets, piston pins, clips

Description	Article Number	G / Pin Diameter	Big End Width	Small End Width	Between Centres	Weight w/o bolts	Price Code
GSXR1000 01-04	PM005	16mm	19.95mm	16mm	111mm	268gr.	D
GSXR1000 05-08	PM006	15mm	19.95mm	16mm	111mm	263gr.	D
Hayabusa 99-07	PM002	20mm	21mm	21mm	119.50mm		D
Hayabusa 08-09	PM003	18mm	21mm	21mm	119.50mm		D

## YAMAHA 4-stroke



set includes											extra parts	
												

Model	Years	Displ. (cc)	Piston Size (mm)	Over-sizes (mm)	Piston Kit Part No.	Dome Volume (cm <sup>3</sup> )	Comp. Height (mm)	Ring Set Part No.	Clip Part No.	Pin Part No.	Price-code	Top End Gasket Kit	Wössner Connecting Rods
YZF1000 13.5:1	04-06	-	76.96	Std.	K8752DA-4	-	-	770XKS	-	-	10	-	-
YZF1000 13.5:1	07-09	-	76.96	Std.	K8753DA-4	-	-	770XKS	-	-	10	-	-
FZR1000R *	89-96	1040	76.93	+2.5	K8529DA-4	-	23	770XKS	CW19	WP028	10	-	-

all 4 cylinder kits include: (4) pistons, ring sets, piston pins, clips



## CONRODS 2-stroke



Part No.	Fits Modells	Pricecode
P2001	Kawa. KX60 84-03	P1
P2001	Kawa. KX65 00-09	
P2001	Suz. RM65 03-05	
P2002	KTM SX65 03-07	P2
P2003	Honda CR80 86-02	
P2003	Honda CR85 03-07	
P2005	Kawa. KX80 98-00	
P2005	Kawa. KX85 01-10	
P2006	KTM SX85 03-08	
P2006	KTM SX105 03-10	
P2007	Suz. RM85 02-09	
P2008	Yam. YZ80 93-01	
P2008	Yam. YZ85 02-09	
P2009	Honda CR125 88-07	P3
P2010	Kawa. KX125 03-05	
P2011	KTM SX125 98-06	
P2011	KTM EXC125 98-06	
P2012	KTM SX125 07-09	
P2012	KTM EXC125 07-09	
P2012	KTM SX144 07-08	
P2012	KTM SX150 09	
P2013	Suz. RM125 99-03	
P2014	Suz. RM125 97-98	
P2015	Suz. RM125 88-96	
P2016	Suz. RM125 04-07	
P2017	Yam. YZ125 01-04	
P2018	Yam. YZ125 05-10	
P2019	Yam. YZ125 97-00	
P2020	Honda CR250 02-07	P4
P2021	Honda CR250 84-01	
P2021	Honda ATC250 85-86	
P2021	Honda TRX250 86	
P2021	Kawa. KX250 78-07	
P2022	Kawa. KX250 04-08	
P2022	Kawa. KDX250 91-94	
P2023	KTM EXC250 04-08	
P2023	KTM SX250 04-10	

Part No.	Fits Modells	Pricecode
P2023	KTM EXC300 04-08	P4
P2024	KTM EXC250 90-99	
P2024	KTM EXC300 90-03	
P2025	Suz. RM250 03-08	
P2026	Suz. RM250 96-02	
P2027	Suz. RM250 87-95	
P2028	Yam. YZ250 99-09	
P2029	Yam. YZ250 90-98	
P2030	Yam. YFS200 Blaster 89-06	
P2031	KTM XC200 98-10	
P2033	Kawa. KDX200 89-06	P3
P2033	Kawa. KDX220 97-05	
P2033	Kawa. KX125 88-91	
P2033	Kawa. KX60 00-03	
P2034	Kawa. KX125 98-02	
P2035	Yam. RD, YFZ350 Banshee	P2
P2036	Kawa. KX80 82-87	
P2036	Kawa. KDX80 82-97	P3
P2036	Kawa. KX100 95-97	
P2037	Kawa. KX125 79-87 / 92-93	P4
P2038	Kawa. KX125 03-05	
P2039	Kawa. KX500 85-04	P3
P2040	Honda CR125 81-84	
P2040	Suz. RM125 84-86	P4
P2041	Honda CR125 85-87	
P2042	Honda TRX250 87-89	P3
P2043	Honda ATC250 81-84	
P2044	Honda CR500	P4
P2045	Suz. LT250 87-92	
P2046	Suz. LT500 87-90	P3
P2047	Yam. YZ125 86-96	
P2048	Yam. YZ250 83-89	P4
P2049	Yam. YZF350 Banshee stroker rod 87-06	

## CONRODS 4-stroke



Part No.	Fits Modells	Pricecode	
P4001	Honda CRF250 04-10	P5	
P4002	Kawa. KXF250 04-10		
P4002	Suz. RMZ250 04-10		
P4003	KTM SXF250 05-10		
P4004	Suz. RMZ250 07-10		
P4005	Yam. YZF250 03-10		
P4006	Yam. YZF250 01-02	P6	
P4007	Yam. YZF450 03-05		
P4008	Yam. YZF450 06-09		
P4009	Kawa. KLX400 03-04		
P4009	Kawa. KFX400 03-06		
P4009	Suz. DRZ400 00-08		
P4009	Suz. LTZ400 03-09		
P4010	Kawa. KXF450 07-08		
P4011	Suz. LTR450 06-09		
P4012	Suz. RMZ450 05-07		
P4013	Suz. RMZ450 08-10		
P4014	KTM LC4 03-07		P7
P4015	KTM EXC450 03-07		P6
P4015	KTM SXF450 03-04		
P4015	KTM EXC525 03-07		
P4016	KTM EXC450 08-10		
P4017	KTM SXF450 07-10		
P4018	KTM SXF450 05-06		
P4019	Kawa. KFX450 08-09		
P4020	Kawa. KXF450 09-10		
P4021	Honda TRX400EX 99-08		
P4022	Honda TRX450 04-05		
P4023	Honda TRX450 06-09		
P4024	Honda CRF150 07-09	P3	
P4025	Honda XR250 86-04	P5	
P4026	Honda CRF450 02-08	P6	
P4027	Honda CRF450 09-10		
P4028	Honda XR600 85-01	P7	
P4028	Honda XL600 83-87		
P4029	Yam. YFZ450 04-05	P6	
P4030	Yam. YFZ450 06-09		

Part No.	Fits Modells	Pricecode
P4031	Yam. YFM700 Raptor 06-09	P7
P4032	Yam. YZF450 2010	P6
P4033	Honda XR400 96-04	
P4034	Suz. LT230 87-94	P5
P4035	Yam. YFM250 Raptor 08-09	
P4036	Yam. YFM350 Raptor 87-09	
P4037	Yam. YFM660 Raptor 2001	P7
P4038	Yam. YFM660 Raptor 02-05	
P4038	Yam. YFM660 Grizzly 02-08	
P4038	Yam. YFM660 Rhino 04-07	

## TOP END GASKETS



2-stroke			
Part No.	Fits Modells	Pricecode	
D2001	Honda CR8503-07	D2	
D2002	Honda CR125 90-97	D3	
D2003	Honda CR125 98-99		
D2004	Honda CR125 00-02		
D2005	Honda CR125 03		
D2006	Honda CR125 04		
D2007	Honda CR125 05-07		
D2008	Honda CR250 92-01		D4
D2009	Honda CR250 02-07		D3
D2010	HVA CR125 97-09		
D2011	Kawa. KX65 00-09	D1	
D2011	Suz. RM65 03-05	D2	
D2012	Kawa. KX85 01-09		
D2012	Kawa. KX80 98-00	D3	
D2013	Kawa. KX125 03-08		
D2014	Kawa. KX250 01-04	D4	
D2015	Kawa. KX250 05-08	D4	
D2016	KTM SX65 09-10	D1	
D2017	KTM SX 85 03-09	D2	
D2018	KTM EXC125 98-01	D3	
D2019	KTM SX65 98-01	D1	
D2020	KTM SX65 02-08		
D2021	KTM EXC 125 02-10	D3	
D2022	KTM SX200 02-09	D4	
D2023	KTM EXC200 99-03		
D2024	KTM SX250 04-06		
D2025	KTM SX250 07-10		
D2026	Suz. RM85 02-08	D2	
D2027	Suz. RM125 98-08	D3	
D2028	Suz. RM250 89-90	D4	
D2029	Suz. RM250 91-95		
D2030	Suz. RM250 96-98		
D2031	Suz. RM250 99-00		
D2032	Suz. RM250 01-02		
D2033	Suz. RM250 03-08		
D2034	Yam. YZ85 02-10	D2	
D2035	Yam. DT125 56-58mm	D3	
D2036	Yam. DT125 58.50-61mm		
D2037	Yam. Yz125 94-98		
D2038	Yam. YZ125 99-04		
D2039	Yam. YZ125 05-09		

D2040	Yam. YZ250 88-96	D4
D2041	Yam. YZ250 99-09	
D2042	GASGAS EC, MC, SM125 01-09	D3
D2043	KTM SX125 02-10	
4-stroke		
Part No.	Fits Modells	Pricecode
D4001	Honda CRF150 07-09	D5
D4002	Honda CRF230 03-09	D6
D4003	Honda XL/XR250 91-96 74mm	
D4004	Honda CRF250 04-09	
D4005	Honda CRF250 10	
D4006	Honda CRF450 02-06	D7
D4007	Honda CRF450 07-08	
D4008	Honda CRF450 09	
D4009	Honda TRX450 04-05 94mm	
D4010	Honda TRX450 04-05 97mm	
D4011	Honda TRX450 06-09	D8
D4012	HVA TC610 92-01	
D4013	Kawa. KXF250 04-08	D6
D4013	Suz. RMZ250 04-06	
D4014	Kawa. KXF250 09	D8
D4015	Kawa. KXF450 06-08	
D4016	Kawa. KXF450 09	D7
D4017	Kawa. KFX450 08-10	
D4018	KTM SXF250 06-09	D6
D4019	KTM SXF450 07-10	D7
D4020	KTM SXF450 02-06	
D4021	KTM SX, EXC520/525 00-07	D8
D4022	Suz. RMZ250 07-09	D6
D4023	Suz. DRZ/LTZ/KFX400	D7
D4024	Suz. RMZ450 05-06	
D4025	Suz. RMZ450 07	
D4026	Suz. RMZ450 08-10	
D4027	Suz. LTR450 06-09 96mm	
D4028	Suz. LTR450 06-09 100mm	
D4029	Yam. YZF250 01-09	D6
D4030	Yam. YZF450 03-05	D7
D4031	Yam. YZF450 06-09	
D4032	Yam. YFZ450 04-09	

## NEEDLE BEARINGS



Part No.	INxEXxlenght Dimensions	Pricecode
N1036	12x16x15.8	N1
N1004	12x17x14.2	
N1006	14x18x16.5	
N1007	14x18x17.2	
N1008	14x18x19.8	
N1009	15x19x16.8	
N1010	15x19x19.5	
N1011	15x20x17.8	
N1012	16x20x17.3	
N1013	16x20x19.5	
N1014	16x20x22.5	
N1015	16x21x17.5	
N1016	16x21x19.5	
N1017	16x21x22.5	
N1020	18x22x19.8	
N1021	18x22x21.8	
N1022	18x23x21.8	
N1025	20x24x22.5	
N1027	20x25x21.8	
N1029	20x25x24.8	
N1030	20x25x27.8	
N1031	20x26x23.8	
N1032	21x25x23.8	
N1034	22x27x24.8	
N1037	12x15x16.3	
N1043	15x19x17.8	
N1047	15x19x17.3	

## PINLIST



	Part No.	Dimension	Type	Weight in grams	Clip	Pricecode
Ø12	WP091	12x8x37.5	S	18	CW12	13
Ø13	WP088	13x8x40	CT	24	CW13	13
Ø14	WP058	14x10x38.5	T	21	CW14	13
	WP025	14x9.0x45	S	31		13
	WP063	14x8.5x38.5	CT	28		13
Ø15	WP032	15x10x45	T	33	CW15	13
	WP011	15x9.0x45	S	39		13
	WP067	15x10x41	T	29		13
Ø16	WP087	16x10x37	CT	33	CW16	13
	WP036	16x10x45	T	41		13
	WP041	16x10.5x51	T	42		13
	WP959	16x9.0x45	CT	44		13
	WP027	16x11x56.2	T	44		13
	WP066	16x9x42	CS	45		13
Ø17	WP083	17x10x46	CT	49	CW17	13
	WP090	17x10x51	CT	55		13
	WP089	17x10x58	CT	63		13
	WP045	17x11x61	CS	63		13
Ø18	WP054	18x11x45	CT	54	CW 18	13
	WP049	18x12x45	CT	45		13
	WP099	18x10x51	CT	68		13
	WP053	18x9.0x51	T	71		13
	WP031	18x11x51	CT	60		13
	WP039	18x12x56	T	59		13
	WP042	18x11x62.8	T	71		13
	WP040	18x13x53.2	T	47		13
	WP033	18x13x56.2	T	49		13
	WP064	18x10x56	CS	76		
Ø18.5	WP084	18.5x11x55.5	CT	71	CW19	13
Ø19	WP037	19x10x51	T	75	CW19	13
	WP028	19x12x46	CT	56		13
	WP018	19x12x48	CT	58		13
	WP050	19x12x51	CT	61		13
	WP026	19x12x55.5	CT	68		13
	WP044	19x13x56.4	T	62		13
	WP019	19x13x61	S	73		13
Ø19.46	WP096	19.46x12x51	CT	66	CW20	13
	WP035	19.46x12x61	CT	80		13

## PINLIST



	Part No.	Dimension	Type	Weight in grams	Clip	Pricecode
Ø20	WP052	20x12.5x55	CT	79	CW20	14
	WP029	20x13x46	CT	58		14
	WP038	20x13x51	T	66		14
	WP061	20x11x61	CS	105		14
	WP086	20x13x61	T	79		14
	WP065	20x11x55	CS	93		14
	WP068	20x12x51	CR	75		14
Ø20.12	WP020	0,792"x12x51	CT	73	CW21	14
	WP021	0,792"x12x56	CT	82		14
	WP093	0,792"x13x72	CS	104		14
Ø20.63	WP095	0,812"x13x55.5	CT	79	CW21	14
Ø21	WP013	21x13.5x46	CT	73	CW21	14
	WP051	21x13.5x51	CT	75		14
	WP034	21x13x55.5	CT	86		14
	WP092	21x12x61	CS	111		14
	WP081	21x14x61	T	82		14
Ø22	WP097	22x12x46	CS	96	CW22	14
	WP055	22x14x46	CT	69		14
	WP009	22x14x51	CT	76		14
	WP098	22x13x51	CS	99		14
	WP017	22x14x55	CT	87		14
	WP046	22x14x63	CT	98		14
	WP080	22x15x61	T	87		14
	WP069	22x14x63	C	104		14
Ø22.22	WP085	0,875"x14x63	CT	105	CW23	14
Ø23	WP008	23x13x50.5	CT	98	CW23	14
	WP047	23x13x50.5	CS	112		14
	WP024	23x15x55.5	CT	95		14
	WP094	23x13x61	CT	126		14
Ø23.55	WP056	0,927"x15.9x56	CT	96	CW24	14
	WP060	0,927"x15.9x51	CT	86		14
Ø24	WP023	24x16x51	CT	92	CW24	14
	WP057	24x17x56	CT	90		14
	WP022	24x16x63.5	CT	121		14

T= Conical shape

S= Cylindrical shape

C= Chromium plated for plain bearings only

R= Inside radius



## RINGLIST 2-stroke



All Woessner rings can be used in cast iron, Nikasil®, boron composite® and Electrofusion bores.

Caution: Wössner 2-stroke rings can not be used in chrome plated bores.

Ring Part No.	Fits Bore dia.	Ring height	Ring width	Pricecode
RxB4700	47	1	1,85	
RxB4750	47,5	1	1,85	
RxB4800	48	1	2,05	
RxB4850	48,5	1	2,05	
RxB4900	49	1	2,05	
RxB4950	49,5	1	2,05	
RxB5000	50	1	2,05	
RxB5050	50,5	1	2,05	
RxB5100	51	1	2,05	
RxB5150	51,5	1	2,05	
RxB5200	52	1	2,05	
RxB5250	52,5	1	2,05	
RxB5300	53	1	2,05	
RxB5350	53,5	1	2,05	
RxB5400	54	1	2,3	
RxB5425	54,25	1	2,3	
RxB5450	54,5	1	2,3	
RxB5475	54,75	1	2,3	
RxB5500	55	1	2,3	
RxB5525	55,25	1	2,3	
RxB5550	55,5	1	2,3	
RxB5600	56	1	2,3	
RxB5625	56,25	1	2,3	
RxB5650	56,5	1	2,3	
RxB5675	56,75	1	2,3	
RxB5700	57	1	2,3	
RxB5725	57,25	1	2,3	
RxB5750	57,5	1	2,3	
RxB5800	58	1	2,3	
RxB5850	58,5	1	2,3	
RxB5900	59	1	2,65	
RxB6000	60	1	2,65	
RxB6250	62,5	1	2,65	
RxB6400	64	1	2,65	
RxB6425	64,25	1	2,65	
RxB6450	64,5	1	2,65	
RxB6475	64,75	1	2,65	
RxB6500	65	1	2,65	
RxB6525	65,25	1	2,65	
RxB6550	65,5	1	2,65	
RxB6600	66	1	2,65	
RxB6625	66,25	1	2,65	
RxB6640	66,4	1	2,65	
RxB6650	66,5	1	2,65	
RxB6675	66,75	1	2,65	
RxB6700	67	1	2,65	
RxB6740	67,4	1	2,65	

Double Ring 17  
Single Ring 16

## RINGLIST 2-stroke



All Woessner rings can be used in cast iron, Nikasil®, boron composite® and Electrofusion bores.

Caution: Wössner 2-stroke rings can not be used in chrome plated bores.

Ring Part No.	Fits Bore dia.	Ring height	Ring width	Pricecode
RxB6750	67,5	1	2,65	Double Ring 17 Single Ring 16
RxB6800	68	1	2,8	
RxB6825	68,25	1	2,65	
RxB6850	68,5	1	2,65	
RxB6875	68,75	1	2,65	
RxB6900	69	1	2,65	
RxB6925	69,25	1	2,65	
RxB6950	69,5	1	2,8	
RxB7000	70	1	2,65	
RxB7050	70,5	1	2,65	
RxB7100	71	1	2,8	
RxB7150	71,5	1	2,65	
RxB7200	72	1	2,65	
RxB7250	72,5	1	2,65	
RxB7300	73	1	2,65	
RxB7350	73,5	1	2,65	
RxB7400	74	1	2,65	
RxB7450	74,5	1	2,65	
RxC7500	75	1,2	3,2	
RxC7550	75,5	1,2	3,2	
RxC7600	76	1,2	3,2	
RxC7650	76,5	1,2	3,2	
RxC7800	78	1,2	3,2	
RxC7850	78,5	1,2	3,2	
RxC7900	79	1,2	3,2	
RxD7900	79	1,5	3,15	
RxC8000	80	1,2	3,2	
RxC8050	80,5	1,2	3,2	
RxC8100	81	1,2	3,2	
RxC8150	81,5	1,2	3,2	
RxC8200	82	1,2	3,2	
RxC8300	83	1,2	3,2	
RxC8350	83,5	1,2	3,2	
RxC8400	84	1,2	3,2	
RxC8450	84,5	1,2	3,2	
RxC8500	85	1,2	3,2	
RxC8550	85,5	1,2	3,4	
RxC8600	86	1,2	3,2	
RxC8650	86,5	1,2	3,2	
RxC8700	87	1,2	3,2	
RxC8750	87,5	1,2	3,2	
RxB8800	88	1,2	3,6	
RxB8900	89	1,2	3,6	
RxB8950	89,5	1,2	3,6	
RxB9000	90	1,2	3,6	
RxB9050	90,5	1,2	3,6	
RxB9100	91	1,2	3,6	

## RINGLIST 4-stroke



All Woessner rings can be used in cast iron, Nikasil®, boron composite® and Electrofusion bores.

Caution: Wössner 4-stroke rings can not be used in chrome plated bores.

Ring Part No.	Fits Bore dia.	Top Ring (mm)	Second Ring (mm)	Oil-Ring (mm)	Pricecode
530XKS	53	1x2.4	0.8x2.5	2x2.4	18
535XKS	53,5	1x2.4	0.8x2.5	2x2.4	18
540XKS	54	1x2.4	0.8x2.5	2x2.4	18
545XKS	54,5	1x2.4	0.8x2.5	2x2.4	18
550XKS	55	1x2.4	0.8x2.5	2x2.4	18
560XKS	56	1x2.4	0.8x2.5	2x2.4	18
570XKS	57	1x2.4	0.8x2.5	2x2.4	18
580XKS	58	1x2.4	0.8x2.5	2x2.4	18
590XKS	59	1x2.4	0.8x2.5	2x2.4	18
595XKS	59,5	1x2.4	0.8x2.5	2x2.4	18
600XGS	60	1x2.65	1x2.7	2x2.7	18
605XGS	60,5	1x2.65	1x2.7	2x2.7	18
610XKS	61	1x2.4	0.8x2.5	2x2.4	18
615XKS	61,5	1x2.4	0.8x2.5	2x2.4	18
620XKS	62	1x2.4	0.8x2.5	2x2.4	18
625XKS	62,5	1x2.4	0.8x2.5	2x2.4	18
630XKS	63	1x2.4	0.8x2.5	2x2.4	18
635XKS	63,5	1x2.4	0.8x2.5	2x2.4	18
640XKS	64	1x2.4	0.8x2.5	2x2.4	18
645XKS	64,5	1x2.4	0.8x2.5	2x2.4	18
650XGS	65	1x2.65	1x2.7	2x2.7	18
655XGS	65,5	1x2.65	1x2.7	2x2.7	18
660XKS	66	1x2.4	0.8x2.5	2x2.4	18
665XKS	66,5	1x2.4	0.8x2.5	2x2.4	18
670XKS	67	1x2.4	0.8x2.5	2x2.4	18
675XKS	67,5	1x2.4	0.8x2.5	2x2.4	18
680XKS	68	1x2.4	0.8x2.5	2x2.4	18
685XKS	68,5	1x2.4	0.8x2.5	2x2.4	18
690XKS	69	1x2.4	0.8x2.5	2x2.4	18
695XKS	69,5	1x2.4	0.8x2.5	2x2.4	18
700XDS	70	1x3.1	1.2x3.5	2x2.7	18
705XDS	70,5	1x3.1	1.2x3.5	2x2.7	18
710XDS	71	1x3.1	1.2x3.5	2x2.7	18
715XDS	71,5	1x3.1	1.2x3.5	2x2.7	18
720XDS	72	1x3.1	1.2x3.5	2x2.7	18
725XDS	72,5	1x3.1	1.2x3.5	2x2.7	18
730XDS	73	1x3.1	1.2x3.5	2x2.7	18
735XDS	73,5	1x3.1	1.2x3.5	2x2.7	18
740XDS	74	1x3.1	1.2x3.5	2x2.7	18
745XDS	74,5	1x3.1	1.2x3.5	2x2.7	18
750XDS	75	1x3.1	1.2x3.5	2x2.7	18
755XDS	75,5	1x3.1	1.2x3.5	2x2.7	18
755XTZ	75,5	1.5x3.1	1.2x3.5	2x2.7	18
760XDS	76	1x3.1	1.2x3.5	2x2.7	18
760XTZ	76	1.5x3.1	1.2x3.5	2x2.7	18
760XMS	76	0.8x2.65	0.8x3.1	2x2.7	18
765XDS	76,5	1x3.1	1.2x3.5	2x2.7	18
770XKS	77	1x3.1	0.8x3.1	2x2.7	18
770XDS	77	1x3.1	1.2x3.5	2x2.7	18
770XTZ	77	1.5x3.1	1.2x3.5	2x2.7	18
775XDS	77,5	1x3.1	1.2x3.5	2x2.7	18
775XTZ	77,5	1.5x3.1	1.2x3.5	2x2.7	18

## RINGLIST 4-stroke



All Woessner rings can be used in cast iron, Nikasil®, boron composite® and Electrofusion bores.

Caution: Wössner 4-stroke rings can not be used in chrome plated bores.

Ring Part No.	Fits Bore dia.	Top Ring (mm)	Second Ring (mm)	Oil-Ring (mm)	Pricecode
780XMS	78	0.8x2.65	0.8x3.1	2x2.7	18
780XDS	78	1x3.1	1.2x3.5	2x2.7	18
780XTZ	78	1.5x3.1	1.2x3.5	2x2.7	18
785XDS	78,5	1x3.1	1.2x3.5	2x2.7	18
785XTZ	78,5	1.5x3.1	1.2x3.5	2x2.7	18
787XDS	78,75	1x3.1	1.2x3.5	2x2.7	18
790XMS	79	0.8x2.65	0.8x3.1	2x2.7	18
790XDS	79	1x3.1	1.2x3.5	2x2.7	18
790XTZ	79	1.5x3.1	1.2x3.5	2x2.7	18
795XDS	79,5	1x3.1	1.2x3.5	2x2.7	18
795XTZ	79,5	1.5x3.1	1.2x3.5	2x2.7	18
800XDS	80	1x3.1	1.2x3.5	2x2.7	19
802XDS	80,25	1x3.1	1.2x3.5	2x2.7	19
805XDS	80,5	1x3.1	1.2x3.5	2x2.7	19
805XTZ	80,5	1.5x3.1	1.2x3.5	2x2.7	19
810XSY	81	1x3.1	1.2x3.5	2.5x2.9	19
810XTY	81	1.5x3.1	1.2x3.5	2.5x2.9	19
815XSY	81,5	1x3.1	1.2x3.5	2.5x2.9	19
815XTY	81,5	1.5x3.1	1.2x3.5	2.5x2.9	19
820XSY	82	1x3.1	1.2x3.5	2.5x2.9	19
820XTY	82	1.5x3.1	1.2x3.5	2.5x2.9	19
825XSY	82,5	1x3.1	1.2x3.5	2.5x2.9	19
825XTY	82,5	1.5x3.1	1.2x3.5	2.5x2.9	19
827XSY	82,75	1x3.1	1.2x3.5	2.5x2.9	19
827XTY	82,75	1.5x3.1	1.2x3.5	2.5x2.9	19
830XSY	83	1x3.1	1.2x3.5	2.5x2.9	19
830XTY	83	1.5x3.1	1.2x3.5	2.5x2.9	19
835XSY	83,5	1x3.1	1.2x3.5	2.5x2.9	19
835XTY	83,5	1.5x3.1	1.2x3.5	2.5x2.9	19
840XSY	84	1x3.1	1.2x3.5	2.5x2.9	19
840XTY	84	1.5x3.1	1.2x3.5	2.5x2.9	19
845XSY	84,5	1x3.1	1.2x3.5	2.5x2.9	19
845XTY	84,5	1.5x3.1	1.2x3.5	2.5x2.9	19
850XSY	85	1x3.1	1.2x3.5	2.5x2.9	19
850XTY	85	1.5x3.1	1.2x3.5	2.5x2.9	19
855XSY	85,5	1x3.1	1.2x3.5	2.5x2.9	19
855XTY	85,5	1.5x3.1	1.2x3.5	2.5x2.9	19
860XSY	86	1x3.1	1.2x3.5	2.5x2.9	19
860XTY	86	1.5x3.1	1.2x3.5	2.5x2.9	19
865XSY	86,5	1x3.1	1.2x3.5	2.5x2.9	19
865XTY	86,5	1.5x3.1	1.2x3.5	2.5x2.9	19
870XSY	87	1x3.1	1.2x3.5	2.5x2.9	19
870XTY	87	1.5x3.1	1.2x3.5	2.5x2.9	19
875XSY	87,5	1x3.1	1.2x3.5	2.5x2.9	19
875XTY	87,5	1.5x3.1	1.2x3.5	2.5x2.9	19
880XSY	88	1x3.1	1.2x3.5	2.5x2.9	19
880XTY	88	1.5x3.1	1.2x3.5	2.5x2.9	19
885XSY	88,5	1x3.1	1.2x3.5	2.5x2.9	19
885XTY	88,5	1.5x3.1	1.2x3.5	2.5x2.9	19
890XSY	89	1x3.1	1.2x3.5	2.5x2.9	19
890XTY	89	1.5x3.1	1.2x3.5	2.5x2.9	19
892XSY	89,25	1x3.1	1.2x3.5	2.5x2.9	19

## RINGLIST 4-stroke



All Woessner rings can be used in cast iron, Nikasil®, boron composite® and Electrofusion bores.

Caution: Wössner 4-stroke rings can not be used in chrome plated bores.

Ring Part No.	Fits Bore dia.	Top Ring (mm)	Second Ring (mm)	Oil-Ring (mm)	Pricecode
895XSY	89,5	1x3.1	1.2x3.5	2.5x2.9	19
895XTY	89,5	1.5x3.1	1.2x3.5	2.5x2.9	19
900XSY	90	1x3.3	1.2x3.8	2.5x2.9	19
900XTY	90	1.5x3.3	1.2x3.8	2.5x2.9	19
905XSY	90,5	1x3.5	1.2x3.8	2.5x2.9	19
905XTY	90,5	1.5x3.5	1.2x3.8	2.5x2.9	19
910XSY	91	1x3.5	1.2x3.8	2.5x2.9	19
910XSU	91	1.2x3.7	1.5x3.7	2.5x2.9	19
910XTY	91	1.5x3.7	1.5x3.7	2.5x2.9	19
912XSU	91,2	1.2x3.7	1.5x3.7	2.5x2.9	19
912XTY	91,2	1.5x3.7	1.5x3.7	2.5x2.9	19
915XSY	91,5	1x3.5	1.2x3.8	2.5x2.9	19
920XSY	92	1x3.5	1.2x3.8	2.5x2.9	19
920XSU	92	1.2x3.7	1.2x3.8	2.5x2.9	19
920XTY	92	1.5x3.7	1.2x3.8	2.5x2.9	19
925XSY	92,5	1x3.3	1.2x3.8	2.5x2.9	19
925XTY	92,5	1.5x3.3	1.2x3.8	2.5x2.9	19
930XSY	93	1x3.5	1.2x3.8	2.5x2.9	19
930XTY	93	1.5x3.5	1.2x3.8	2.5x2.9	19
935XSY	93,5	1x3.5	1.2x3.8	2.5x2.9	19
940XSY	94	1x3.5	1.2x4.0	2.5x2.9	19
945XSY	94,5	1x3.5	1.2x4.2	2.5x2.9	19
950XSY	95	1x3.5	1.2x4.0	2.5x2.9	19
955XSY	95,5	1x3.5	1.2x4.0	2.5x2.9	19
955XTY	95,5	1.5x3.5	1.2x4.0	2.5x2.9	19
960XSY	96	1x3.5	1.2x4.0	2.5x2.9	19
960XTY	96	1.5x3.5	1.2x4.0	2.5x2.9	19
965XSY	96,5	1x3.5	1.2x4.0	2.8x2.9	19
970XSY	97	1x3.5	1.2x4.0	2.5x2.9	19
970XTY	97	1.5x3.5	1.2x4.0	2.5x2.9	19
975XSY	97,5	1x3.5	1.2x4.0	2.5x2.9	19
975XTY	97,5	1.5x3.5	1.2x4.0	2.5x2.9	19
980XSY	98	1x3.5	1.2x4.0	2.5x2.9	19
980XTY	98	1.5x3.5	1.2x4.0	2.5x2.9	19
990XSY	99	1x3.5	1.2x4.0	2.5x2.9	19
992XSY	99,2	1x3.5	1.2x4.0	2.5x2.9	19
995XSY	99,5	1x3.5	1.2x4.2	2.5x2.9	19
995XTY	99,5	1.5x3.5	1.2x4.2	2.5x2.9	19
1000XSY	100	1x3.5	1.2x4.0	2.5x2.9	20
1000XTY	100	1.5x3.5	1.2x4.0	2.5x2.9	20
1010XSY	101	1x3.5	1.2x4.0	2.5x2.9	20
1016XSU	101,6	1.2x3.65	1.5x4.2	2.5x2.9	20
1020XSU	102	1.2x3.65	1.5x4.2	2.5x2.9	20
1025XSU	102,5	1.2x3.65	1.5x4.2	2.5x2.9	20
1030XSU	103	1.2x3.65	1.5x4.2	2.5x2.9	20
1035XSU	103,5	1.2x3.65	1.5x4.2	2.5x2.9	20
1040XSU	104	1.2x3.65	1.5x4.2	2.5x2.9	20
1045XSU	104,5	1.2x3.65	1.5x4.2	2.5x2.9	20
1050XSU	105	1.2x3.65	1.5x4.2	2.5x2.9	20
1055XSU	105,5	1.2x3.65	1.5x4.2	2.5x2.9	20
1060XSU	106	1.2x3.65	1.5x4.2	2.5x2.9	20
1065XSU	106,5	1.2x3.65	1.5x4.2	2.5x2.9	20

# GENERAL TERMS AND CONDITIONS

of contracts with Wössner GmbH · Im Wörth 21 · 79576 Weil m Rhein/Märkt

## 1. General

All offers, deliveries, repairs and other services are exclusively rendered on the basis of the following conditions. The applicability of contractual partners' conflicting terms and conditions is herewith denied. Deviations from these terms and conditions have effect only if they are confirmed by us in writing. All other alterations, requested or implied, remain invalid. These Terms and Conditions supersede all previous Terms and Conditions

## 2. Contract-execution and Content

2.1 All offers are subject to confirmation within three weeks and are non-binding.  
2.2 Subsidiary agreements, restrictions, alterations or additions to contracts must be made and accepted in writing.

## 3. Prices and Terms of Payment

3.1 All prices exclude postage and packing.  
Offers are made based upon current costs. Should, between acceptance of an order and delivery date, an unexpected rise in costs occur, we reserve the right to raise our wholesale prices accordingly. The same applies to retail prices only when the delivery date is more than four months after the order was confirmed. An increase in price on a retail contract is restricted to three percent of the original sum.  
3.2 Only written estimates will be considered to be binding. Should we not receive a contract following an estimate we reserve the right to request an appropriate fee for this service.  
3.3 Payment, in Euro, is due in full within one week of the billing date.  
3.4 For delivery contracts we reserve the right to request payment in advance or cash on delivery.  
3.5 Payment by cheques and bills of exchange is only considered to have taken place when the clearing process is completed. Responsibility for the form and acceptance of bills of exchange remains with the drawee. Withdrawal, account and exchange fees are the responsibility of the purchaser and are immediately due.  
3.6 The purchaser is only entitled to an account credit in the event of an unchallenged and legally upheld counter claim. Right of retention claims must be based upon such claims.  
3.7 We reserve the right to off-set payments against outstanding debts in accordance with §§ 367 Abs. 1, 366 Abs. 2 BGB  
3.8 In the event of delay or default in payment we reserve the right to charge interest at a rate of two percent above the base rate as defined by the Deutsche Bundesbank.

## 4. Delivery Dates and Appointments

4.1 Delivery dates and working schedules are only binding when agreed in writing.  
4.2 In the event that we are unable to meet a delivery date, the customer is entitled to set a new delivery date, at least three weeks after the expiry of the original deadline. Only if this second deadline is reached without the delivery taking place is the customer entitled to withdraw from the agreement. The setting of deadlines and the withdrawal from agreements must take place in writing.  
4.3 Force Majeure – events beyond our control, such as, but not restricted to, acts of God, industrial action and state intervention, that hinder us or our suppliers in the completion of our work may lead to an extension of the previously agreed delivery times. Should such events render completion of a contract impossible or the altered conditions unacceptable then either party is entitled, in writing, to withdraw from the agreement. There arises no entitlement to compensation

## 5. Transfer of Responsibility

5.1 We are not liable for loss or damage in transport. Responsibility passes to the customer as the goods are collected or leave our premises. If dispatch is delayed due to events beyond our control then responsibility passes to the customer with the notification of transport readiness. An insurance to cover possible damage or loss during transportation can be arranged on request. The cost of the insurance is the responsibility of the customer.  
5.2 Responsibility for goods in transit to us remains with the customer.

## 6. Reservation of Title – Transfer of Ownership

6.1 The finished goods remain completely the property of Wössner GmbH until such time as all outstanding balances due to us have been paid. In the case of wholesale partners this clause also applies to future balances.  
6.2 If our sole ownership of the goods becomes void through amalgamation or modification, then we receive a proportional ownership of the new retained goods based upon the value of its constituent parts.  
6.3 The customer is entitled to process and sell the retained goods in the due course of his business. Any and all resulting income is payable to Wössner GmbH. Following a specific request from our customer we are willing to release them from this demand in so far as their income is more than twenty percent over our price.

## 7. Guarantee

7.1 Receipt of obviously faulty or incomplete goods must be immediately registered at Wössner GmbH. Notification must reach us within fourteen days of receipt of the goods. The extent of any further testing and the necessity of any further notification, in the case of trade customers, are legally governed. Any complaints concerning the goods must be forwarded in writing together with a copy of the relevant invoice.  
7.2 We reserve the right to dispatch part orders in appropriate circumstances. These will be clearly marked as such and require no notification of missing components. Deviations from agreed or advertised properties of a product that either improve or do not influence its normal or planned usage are not considered to be defects. We reserve the right to make such alterations.  
7.3 Our motor parts, tuning instruments and other accessories are generally delivered without TÜV testing and are only for use in specialised racing vehicles. Licensing for use on normal road vehicles is not part of any agreement.  
7.4 Our guarantee is limited to repair or replacement of the delivered goods. In the event of a further problem after repair or replacement the customer may choose between an appropriate reduction in price or return of the goods and a refund. We reserve the right to two attempts to improve the original merchandise before further action is taken.  
7.5 Faults directly or indirectly attributable to inappropriate handling, attempted repair, inflicted damage or other alterations to the goods carried out by the customer or a third party are not covered by our guarantee. The guarantee becomes void should the customer not follow exactly the instructions contained within the included Installation Manual.  
7.6 For special constructions based upon designs provided by the customer, our guarantee is restricted to the quality of the construction work carried out. All risks relating to technical specification, function and endurance are carried by the customer.  
7.7 Should we discover in the course of a complaints procedure that our guarantee is void, we reserve the right to charge the customer an appropriate fee for time and material costs.  
7.8 The guarantee period is six months.

## 8. Liability

8.1 Except for instances of gross negligence or intentional malpractice, compensation claims arising from positive violation of claims, breach of duty prior to contract (culpa in contrahendo) and from tort are excluded in all instances except those arising from claims based faulty goods.  
8.2 In cases of faulty merchandise liability is excluded for direct and consequential damage which occurs after the defect should reasonably have been identified.  
8.3 Furthermore the amount of compensation for cases involving wholesale transactions is, based upon the foreseeable average damage for this nature of contract, limited to ten times the price of the article or, in the case of modifications, ten times the works costs. Instances involving exceptional risk factors must be registered pre-contract. Liability beyond the limits outlined within this contract will only be accepted if agreed in writing in advance.  
8.4 Liability claims based upon a failure to follow the Installation instructions (Paragraph 7.5) or based upon damage caused as a result of an explicit customer request (Paragraph 7.6) are excluded.

## 9. Final Provisions

9.1 The place of fulfilment of this contract is 79576 Weil am Rhein, Germany. Insofar as the customer is a registered businessman within the bounds of the German Commercial Code, a legal entity under public law or a Special Fund under public law, the exclusive place of jurisdiction for all disputes arising directly or indirectly from the contractual relationship is 79576 Weil am Rhein. The current or usual place of residence of the plaintiff is immaterial.  
9.2 German law is applicable to these General Terms and Conditions and to the entire legal relations between us and the customer. Uniform Sales Law and the United Nations Convention on Contracts for the International Sale of Goods have no jurisdiction. The German version of these terms and Conditions (Allgemeine Geschäftsbedingungen) are binding in content.  
9.3 In the event that a condition in these General Terms and Conditions or a Provision under the structure of other agreements is, or will become invalid, this does not affect the validity of all other conditions or agreements.



**Manufacturer of forged pistons**

**Wössner GmbH**

Im Wörth 21 · 79576 Weil am Rhein · Germany  
Phone +49 (0) 7621 95 66 49-0 · Fax +49 (0) 7621 95 66 49-25  
info@woessner-kolben.de · www.woessner-kolben.de

**Shelf Piston Order Form**

Fax to +49 (0) 7621 95 66 49-25

Account Number \_\_\_\_\_ Date \_\_\_\_\_

Company \_\_\_\_\_

Contact Person \_\_\_\_\_

Street \_\_\_\_\_ Country \_\_\_\_\_

Phone \_\_\_\_\_ Fax \_\_\_\_\_

E-Mail \_\_\_\_\_

Quantity (Set / Each)	Part #	Comments

**We will return a fax confirmation as soon as possible!**

Parts available  Yes  No

Confirmation \_\_\_\_\_





Manufacturer of forged pistons

**Wössner GmbH**

Im Wörth 21 · 79576 Weil am Rhein · Germany  
 Phone +49 (0) 7621 95 66 49-0 · Fax +49 (0) 7621 95 66 49-25  
 info@woessner-kolben.de · www.woessner-kolben.de

## Custom Piston Order Form

Fax to +49 (0) 7621 95 66 49-25

Engine Type \_\_\_\_\_  
 Model \_\_\_\_\_ Year \_\_\_\_\_  
 Number of Cylinders \_\_\_\_\_ Order Quantity of Pistons \_\_\_\_\_  
 Displacement \_\_\_\_\_ Max RPM \_\_\_\_\_ Approx. HP \_\_\_\_\_  
 Bore Size \_\_\_\_\_ Stroke \_\_\_\_\_  
 Rod Length \_\_\_\_\_  
 Rod Small-End Width \_\_\_\_\_  
 Thickness above Pin \_\_\_\_\_  
 Head Gasket Thickness \_\_\_\_\_  
 Compression Ratio \_\_\_\_\_

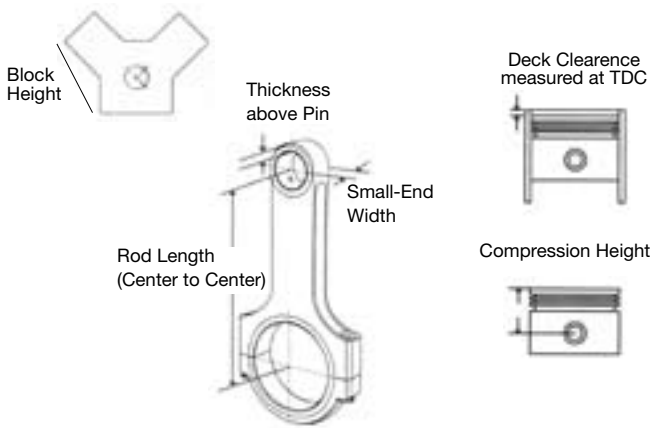

### CYLINDER HEAD

Combustion Chamber Size \_\_\_\_\_ cc's  
 Valve Diameter In \_\_\_\_\_ Ex \_\_\_\_\_  
 Free Drop (if known) \_\_\_\_\_  
 Was cylinder head milled?  Yes  No  
 If cylinder head was milled, how much?  
 Flat \_\_\_\_\_  Angled \_\_\_\_\_

Piston Type (Circle one if known)

Dome  Flat Top  Dish  Inverted Dome  
 Conical  Spherical  Round  3D

Pistons designed for  Circle Track  Asphalt  Dirt  
 Drag Race  Road Race  Marine  Street/Ship  
 other (please specify) \_\_\_\_\_

Is your Motor  Carbureted  Injected  
 Turbo Charged: Lbs. Boost \_\_\_\_\_  Blown: Lbs. Boost \_\_\_\_\_  
 Nitrous – how much HP  100  250  350  400+  
 other (please specify) \_\_\_\_\_  
 Fuel Type  Pump Gas  Race Gas  Alcohol  Nitro

### PIN SPECS

Pin Diameter \_\_\_\_\_ Length \_\_\_\_\_  
 Wall Thickness \_\_\_\_\_ Qty \_\_\_\_\_  
 Pins with Order  Yes  No  
 Pin Fit  Yes  No

**Wössner GmbH reserves the right to choose the appropriate pin length if supplying pins per each piston design.**

### COMPANY INFORMATION

Company \_\_\_\_\_  
 Contact Person \_\_\_\_\_  
 Street \_\_\_\_\_  
 Country \_\_\_\_\_  
 Phone \_\_\_\_\_  
 Fax \_\_\_\_\_  
 E-Mail \_\_\_\_\_

**RETURN POLICY:** Custom pistons are returnable only for defects in workmanship or materials in the as received condition. Under no circumstances will parts be returnable after 90 days. Please check packaging for complete details regarding return policy. All returns require a „Return Materials Authorization“ (RMA) number, available from the Wössner GmbH sales department.





**NOTES**

# NOTES

## Our location in Germany



### **Wössner GmbH**

Im Wörth 21

D-79576 Weil am Rhein/Märkt

Tel. +49 (0) 7621 95 66 49-0

Fax +49 (0) 7621 95 66 49-25

info@woessner-kolben.de

www.woessner-kolben.de



**Manufacturer of forged pistons**

## Headquarters

**Wössner GmbH**

**Im Wörth 21**

**D-79576 Weil am Rhein/Märkt**

**Tel. +49 (0) 7621 95 66 49-0**

**Fax +49 (0) 7621 95 66 49-25**

**info@woessner-kolben.de**

**www.woessner-kolben.de**